



# ST 4", 6" Series

60Hz

Submersible Electric Pumps



STAIRS INDUSTRIAL CO., LTD.

**ST 4" ,6"**
**General Data**

Performance Range	1
Model Code	2
Applications	2
Description	2
General Specifications Pump	2
Materials	3

**ST 4" Technical Data**

ST 05	4
ST 07	6
ST 10	8
ST 13	10
ST 18	12
ST 25	14
ST 35	16
ST 40	18
ST 55	20
ST 60	22
ST 80	24

**ST 6" Technical Data**

ST 50	26
ST 75	28
ST 135	30
ST 180	32
ST 220	34

## 4"&6" ST Submersible Electric Pumps

STAIRS ST Series is a robust 4" pump designed for long life and sand handling. It is built mainly in stainless steel, a casted discharge, a casted bracket and a special floating impeller. The design is to enhance the wear resistance and to maintain the performance over time.

Wide range of application of irrigation systems, pressure boosting, water supply and fountain applications for 4" well. All ST pumps can be coupled to 4" NEMA standard motors.

Stairs 6" ST submersible pumps for high pressures and flow rates, particularly equipped with a high rigidity Silicon-Carbide(SiC) Bearing, provide reliability and quality guaranteed.

### Performance Range

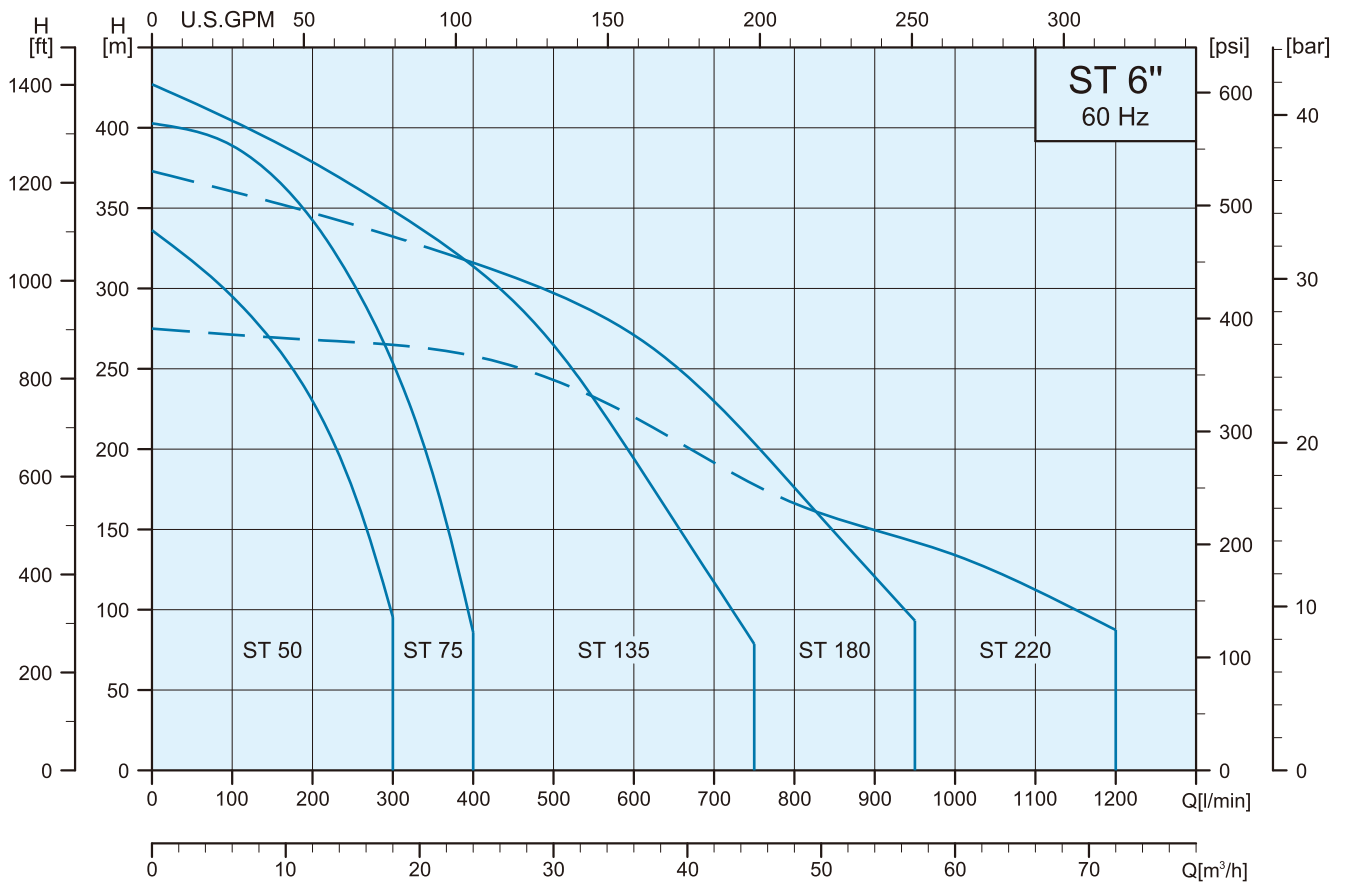
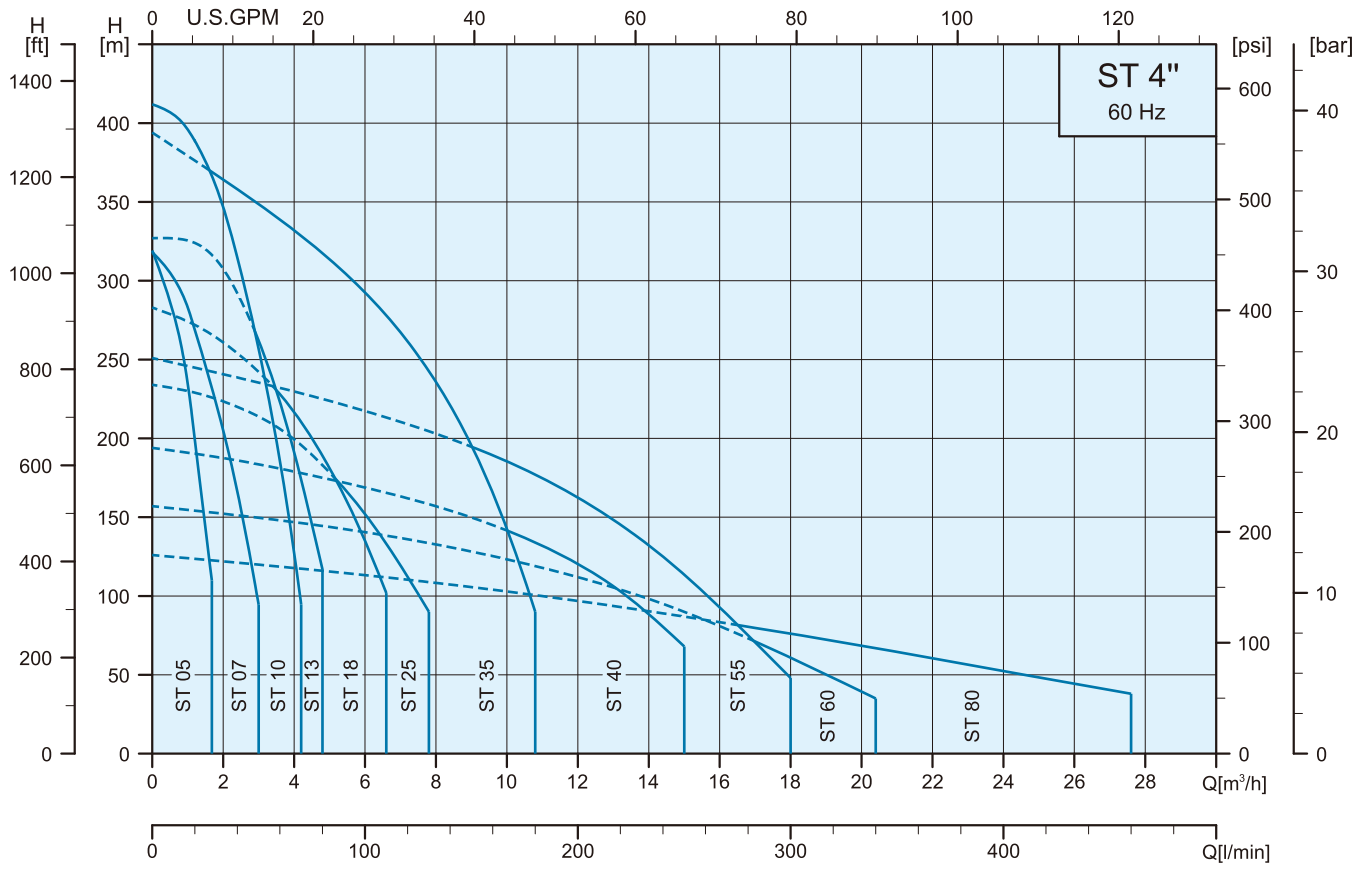



### Model Code

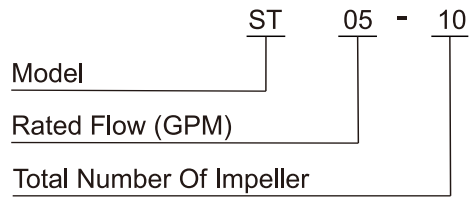

### Applications

- Water Supply
- Irrigation
- Pressure Boosting

## General Specifications Pump

ST 4"	ST 6"
Delivery : up to 27.8 m³/h at 3450 rpm	Delivery : up to 72 m³/h at 3450 rpm
Head : up to 410 m at 3450 rpm	Head : up to 430 m at 3450 rpm
Maximum permissible quantity of sand : 150g/m³	Maximum permissible quantity of sand : 60g/m³
ST05-ST07-ST10-ST13-ST18 models 1 1/4" discharge.	ST 50-ST75-ST135-ST180-ST220 models 3" discharge.
ST25 model 1 1/2" discharge.	
ST35-ST40-ST55-ST60-ST80 models 2" discharge	

### ST 4"

**Bearing** is made with Polyacetal for strong wear and abrasive resistance.

### ST 4",6"

**Discharge Head and Motor Adaptor** are precision machined cast 304 stainless steel for superior strength and durability. The motor adaptor is NEMA standard.

**Impeller Bowls** are made from 304 stainless steel, maximizing wear from abrasion.

**Strainer** is made from stamped 304 stainless steel for rigidity.

**Pump Shaft** is made from hex 304 stainless steel bar material for high corrosion resistance.

**Pump body** is covered by a 4"1.5mm/6"2.0mm thick 304 polished stainless steel casing, ensures optimum resistance to abrasion.

**Impellers are floating type made with Noryl®** for a superior sand handling.

Together with glass filled polycarbonate diffusers make the super strong pumps for maximum wear and abrasive resistance.

The materials are FDA compliant materials.

**Shaft Coupling** is made from 304 stainless steel for easy alignment to the motor shaft.

**Non-Return valve** made from 304 stainless steel, fitted in the discharge to prevent any back flow of water and alleviate any water hammer to the pumps.

### Materials

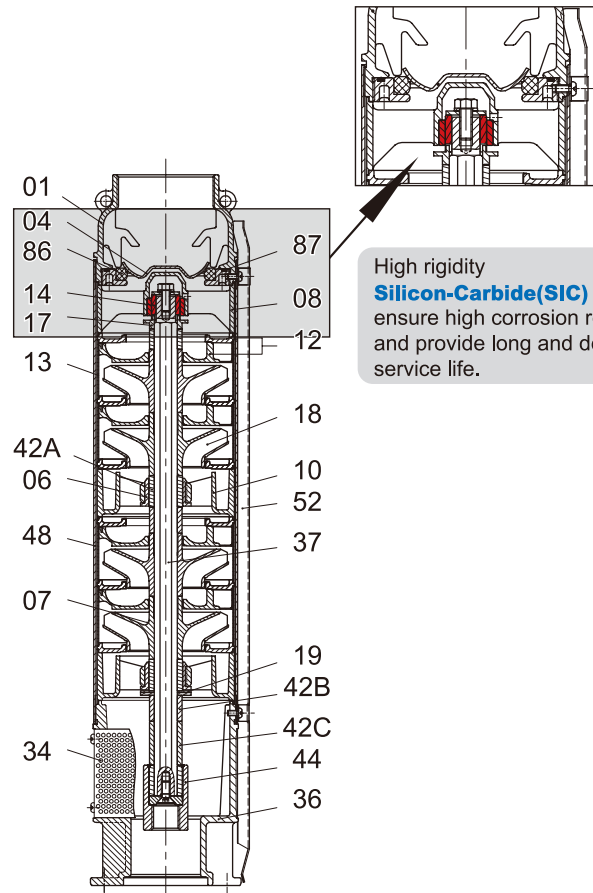
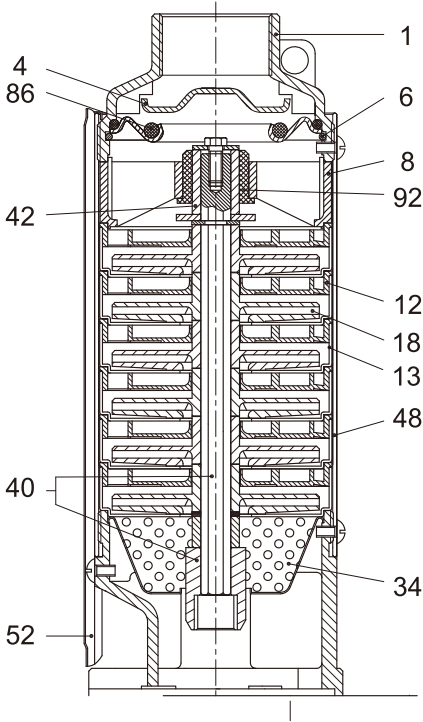

High rigidity **Silicon-Carbide(SiC) Bearing** ensure high corrosion resistance and provide long and dependable service life.

Pos.	Part Name	Materials
1	Discharge Head	AISI304 SS
4	Check Valve Cone	AISI304 SS
6	Check Valve retaining Ring	AISI304 SS
8	Bearing Spider	Glass Filled Polycarbonate
12	Diffuser	Glass Filled Polycarbonate
13	Bowl	AISI304 SS
18	Impeller	Noryl
34	Strainer	AISI304 SS
40	Pump Shaft / Coupling	AISI304 SS
42	Shaft Sleeve	AISI 304 SS or Noryl
48	Pump Casing	AISI304 SS
52	Cable Guard	AISI304 SS
86	O-Ring	NBR
92	Bearing	Polyacetal

Pos.	Part Name	Material
1	Discharge	AISI 304
4	Valve cone	AISI 304
6	Bearing	POM+PTFE
7	Bearing	Bronze
8	Upper bearing spider	AISI 304+ Silicon carbide
10	Bearing Spider	Noryl
12	Diffuser	Glass Filled Polycarbonate
13	Diffuser casing	AISI 304
14	Bearing ring	Silicon carbide
17	Sleeve for baffle	AISI 304
18	Impeller	Noryl
19	Counter thrust bearing plate	Carbon fiber + PTFE
34	Strainer	AISI 304
36	Suction interconnector	AISI 304
37	Pump shaft	AISI 304
42A	Shaft sleeve	AISI 304
42B	Shaft sleeve	Noryl
42C	Shaft sleeve	Noryl
44	Coupling	AISI 304
48	Pump casing	AISI 304
52	Cable guard	AISI 304
86	Valve Seat	AISI 304 + NBR
87	O-ring	NBR

# ST 60Hz

## General Data



### Performance Curves

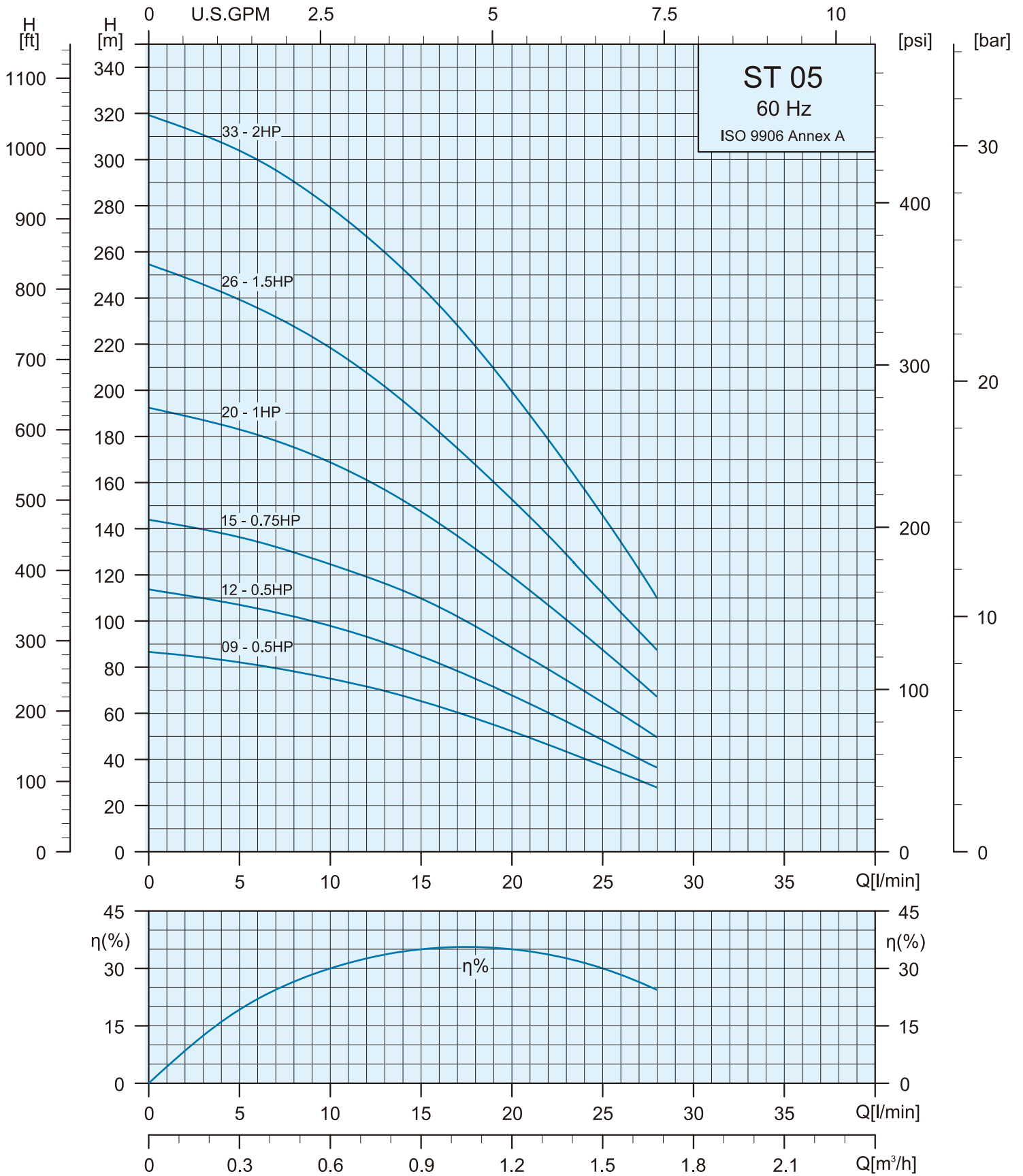

### Specifications

Pump Type	Motor		Q=DELIVERY						
	P <sub>2</sub>		l/min	0	10	15	20	25	30
	kW	HP	m <sup>3</sup> /h	0	0.6	0.9	1.2	1.5	1.8
ST 05-09	0.37	0.5	H (m)	87	75	65	52	38	21
ST 05-12	0.37	0.5		114	98	85	68	49	28
ST 05-15	0.55	0.75		144	124	110	89	65	39
ST 05-20	0.75	1.0		193	169	148	120	88	53
ST 05-26	1.1	1.5		255	219	179	152	112	68
ST 05-33	1.5	2.0		320	280	245	200	145	82

### Dimensions and Weights

Pump Type	Dimensions (mm)			Net Weight (kg)
	A	B	C	PUMP
ST 05-09	306	Rp 1 1/4" NPT 1 1/4"	98	3.1
ST 05-12	359		98	3.6
ST 05-15	411		98	4.1
ST 05-20	499		98	4.9
ST 05-26	642		98	5.8
ST 05-33	820		98	8.3

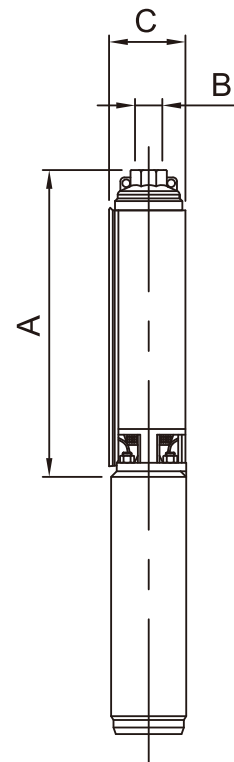



### Performance Curves

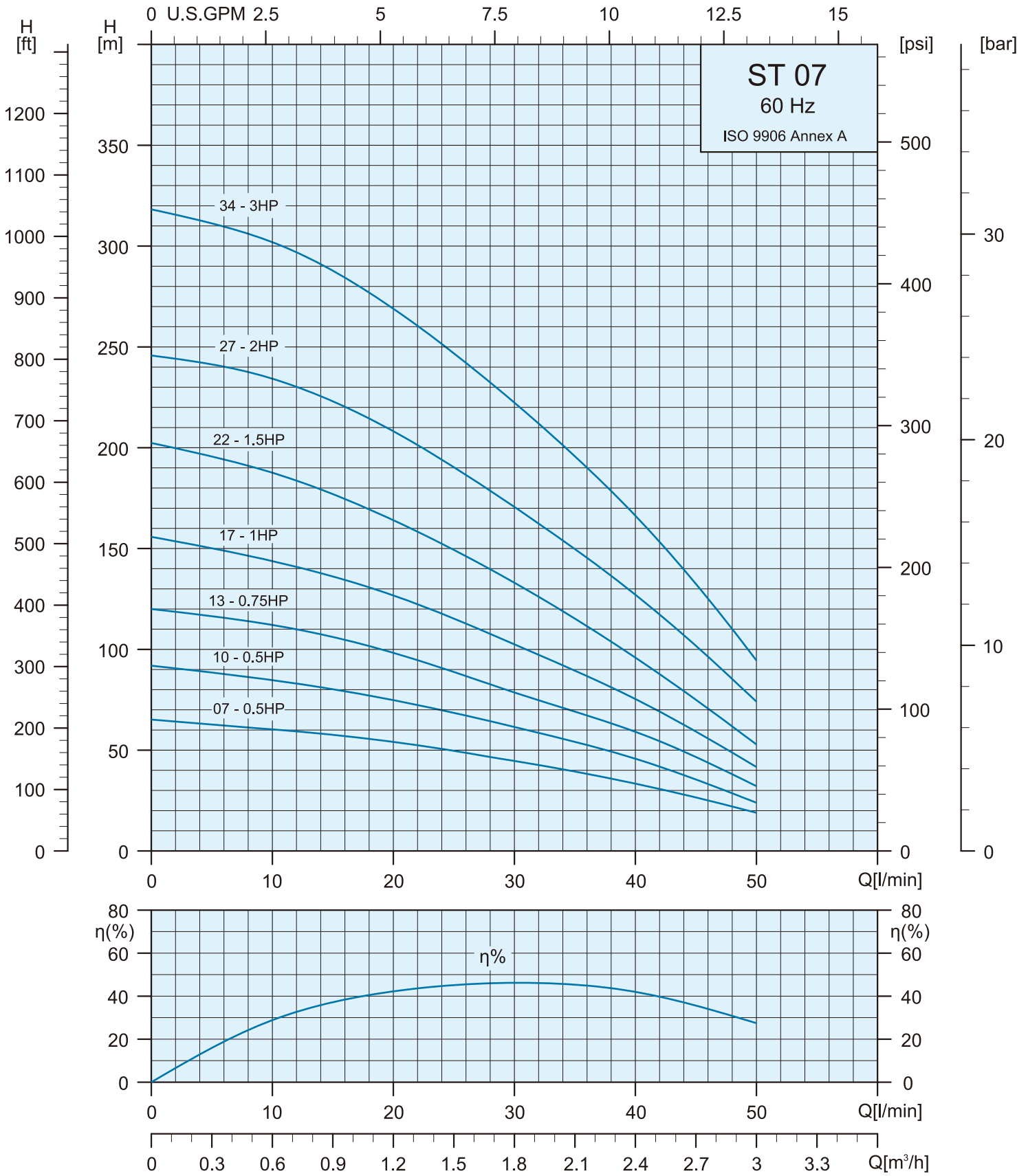

### Specifications

Pump Type	Motor		Q=DELIVERY								
	P <sub>2</sub>		l/min	0	15	20	25	30	35	40	50
	kW	HP	m <sup>3</sup> /h	0	0.9	1.2	1.5	1.8	2.1	2.4	3.0
ST 07-07	0.37	0.5	H (m)	66	57	54	49	44	39	33	19
ST 07-10	0.37	0.5		92	80	75	68	62	54	47	24
ST 07-13	0.55	0.75		120	106	98	89	79	69	59	32
ST 07-17	0.75	1.0		156	136	127	115	102	89	75	42
ST 07-22	1.1	1.5		203	177	165	150	133	115	97	53
ST 07-27	1.5	2.0		246	223	208	190	171	150	127	74
ST 07-34	2.2	3.0		318	288	269	247	223	196	167	95

### Dimensions and Weights

Pump Type	Dimensions (mm)			Net Weight (kg)
	A	B	C	PUMP
ST 07-07	275	Rp 1 1/4" NPT 1 1/4"	98	2.7
ST 07-10	330		98	3.3
ST 07-13	385		98	3.8
ST 07-17	455		98	4.5
ST 07-22	545		98	5.4
ST 07-27	675		98	6.6
ST 07-34	858		98	9.3

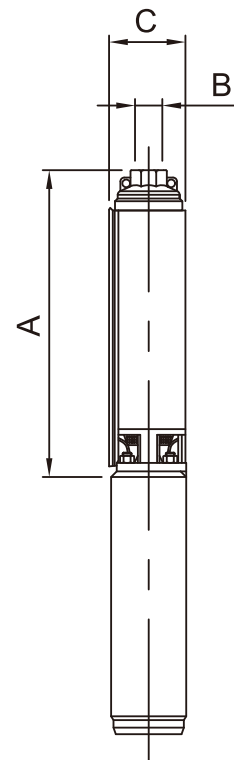

### Performance Curves

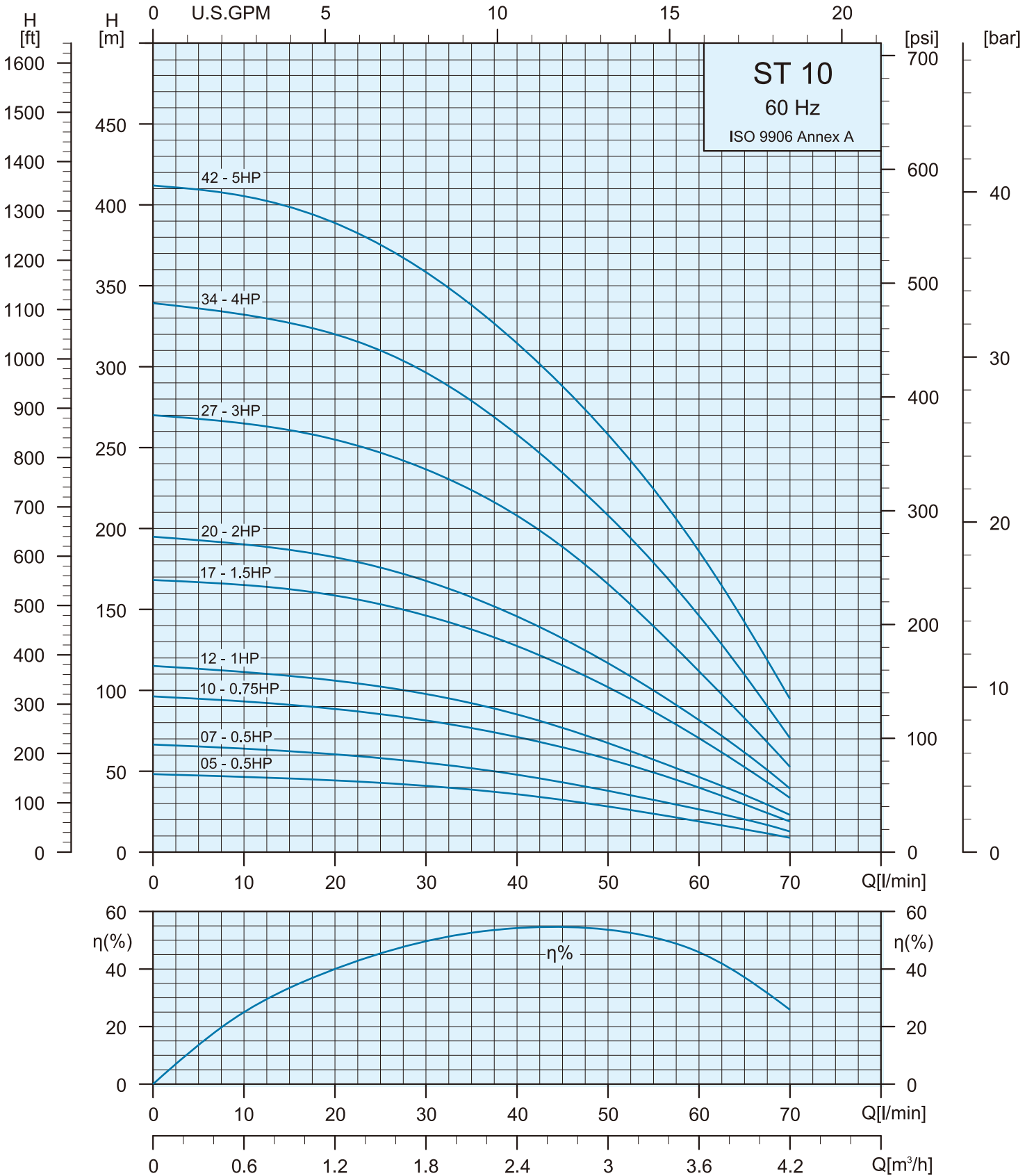

### Specifications

Pump Type	Motor		Q=DELIVERY									
	P <sub>2</sub>		l/min	0	20	25	30	35	40	50	60	70
	kW	HP	m <sup>3</sup> /h	0	1.2	1.5	1.8	2.1	2.4	3.0	3.6	4.2
ST 10-05	0.37	0.5	H (m)	48	44	42	40	38	36	29	19	9
ST 10-07	0.37	0.5		67	60	58	55	52	49	39	27	13
ST 10-10	0.55	0.75		96	89	85	81	77	71	58	40	19
ST 10-12	0.75	1.0		115	106	102	98	92	85	68	47	23
ST 10-17	1.1	1.5		168	159	152	147	138	128	102	70	35
ST 10-20	1.5	2.0		195	181	177	168	158	146	118	82	40
ST 10-27	2.2	3.0		270	255	247	237	223	209	167	111	53
ST 10-34	3.0	4.0		339	320	310	296	280	259	209	146	70
ST 10-42	3.7	5.0		412	389	375	358	338	315	258	186	95

### Dimensions and Weights

Pump Type	Dimensions (mm)			Net Weight (kg)
	A	B	C	PUMP
ST 10-05	236	Rp 1 1/4" NPT 1 1/4"	98	2.5
ST 10-07	271		98	2.8
ST 10-10	324		98	3.3
ST 10-12	359		98	3.6
ST 10-17	447		98	4.4
ST 10-20	499		98	4.9
ST 10-27	660		98	6.0
ST 10-34	840		98	8.5
ST 10-42	980		98	9.8

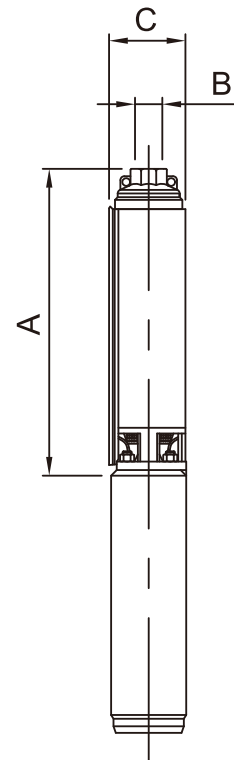

### Performance Curves

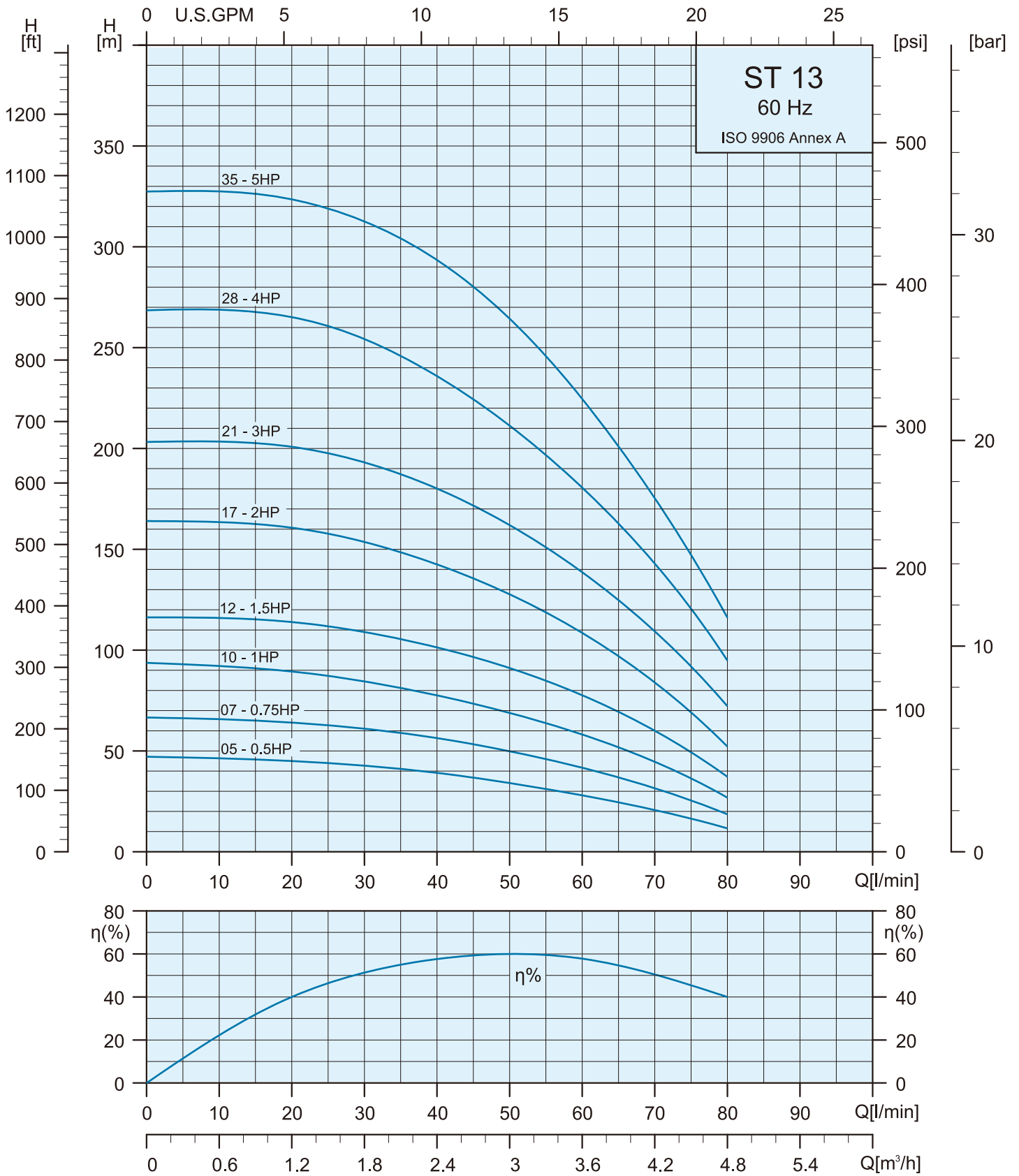

### Specifications

Pump Type	Motor		Q=DELIVERY								
	P <sub>2</sub>		l/min	0	30	35	40	50	60	70	80
	kW	HP	m <sup>3</sup> /h	0	1.8	2.1	2.4	3.0	3.6	4.2	4.8
ST 13-05	0.37	0.5	H (m)	47	42	40	39	34	28	21	12
ST 13-07	0.55	0.75		67	61	59	57	50	41	31	19
ST 13-10	0.75	1.0		94	85	81	78	69	58	45	28
ST 13-12	1.1	1.5		116	109	106	102	91	78	60	38
ST 13-17	1.5	2.0		165	154	148	143	128	109	83	53
ST 13-21	2.2	3.0		204	193	187	180	162	139	110	72
ST 13-28	3.0	4.0		269	254	246	236	211	180	142	96
ST 13-35	3.7	5.0		327	312	304	292	264	223	175	117

### Dimensions and Weights

Pump Type	Dimensions (mm)			Net Weight (kg)
	A	B	C	PUMP
ST 13-05	236	Rp 1 1/4" NPT 1 1/4"	98	2.5
ST 13-07	271		98	2.8
ST 13-10	324		98	3.2
ST 13-12	359		98	3.5
ST 13-17	447		98	4.3
ST 13-21	519		98	5.0
ST 13-28	679		98	6.0
ST 13-35	857		98	8.6

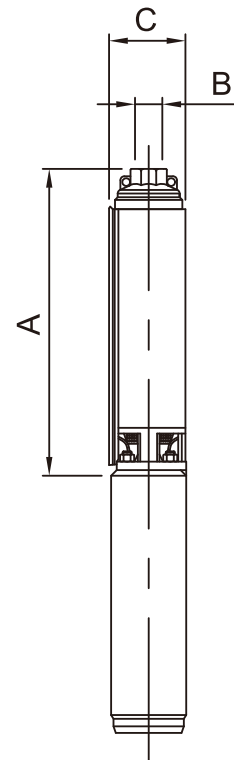

### Performance Curves

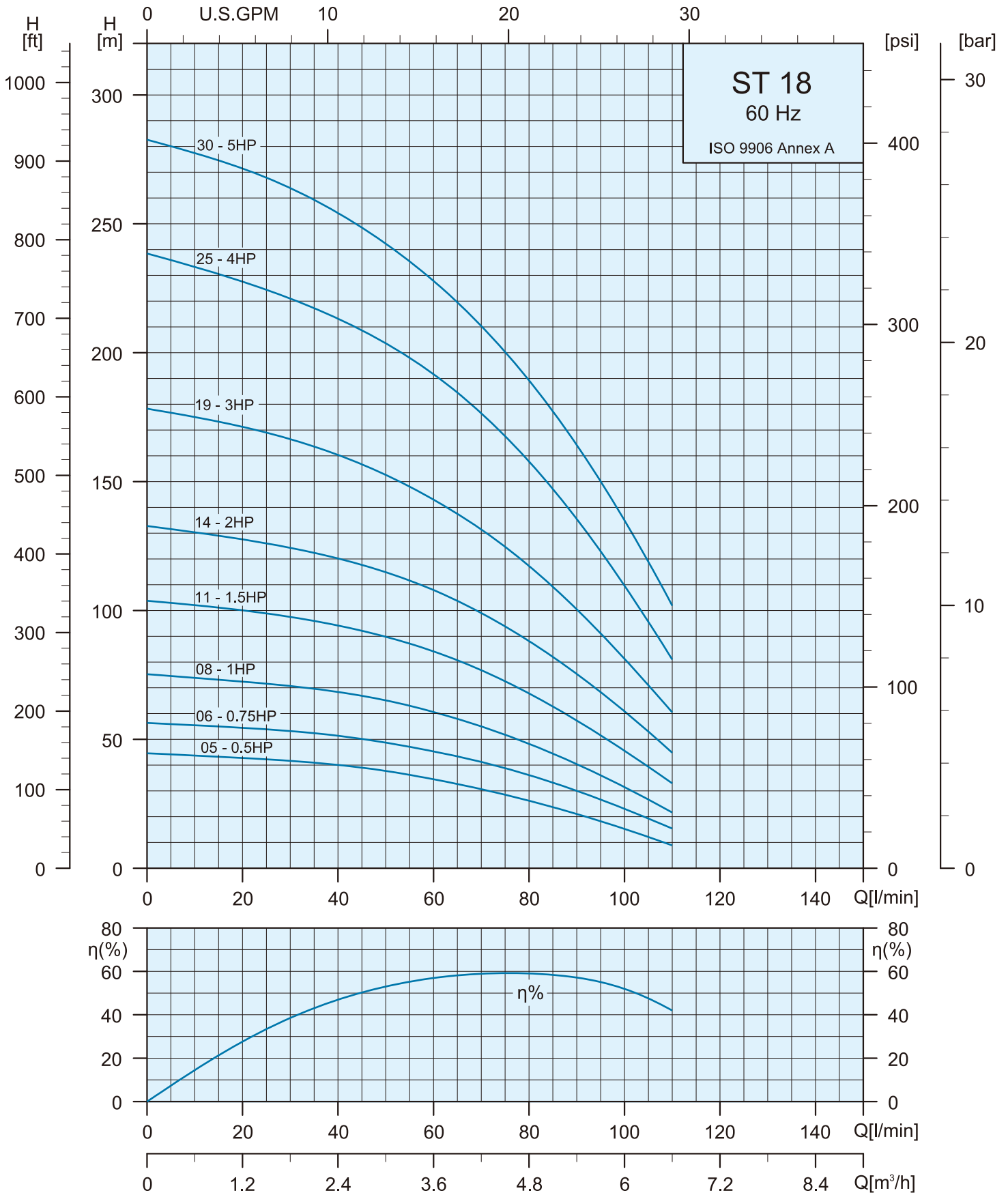

### Specifications

Pump Type	Motor		Q=DELIVERY										
	P <sub>2</sub>		l/min	0	35	40	50	60	70	80	90	100	110
	kW	HP	m <sup>3</sup> /h	0	2.1	2.4	3.0	3.6	4.2	4.8	5.4	6.0	6.6
ST 18-05	0.37	0.5	H (m)	45	41	40	38	35	31	27	21	15	9
ST 18-06	0.55	0.75		56	53	52	49	45	41	37	30	23	16
ST 18-08	0.75	1.0		75	70	68	65	61	55	49	41	32	22
ST 18-11	1.1	1.5		104	96	94	90	84	77	68	58	46	33
ST 18-14	1.5	2.0		133	123	120	115	108	99	88	75	61	45
ST 18-19	2.2	3.0		178	164	160	153	143	131	117	100	81	61
ST 18-25	3.0	4.0		238	217	213	204	192	176	158	136	110	81
ST 18-30	3.7	5.0		283	260	254	242	228	210	189	164	135	102

### Dimensions and Weights

Pump Type	Dimensions (mm)			Net Weight (kg)
	A	B	C	PUMP
ST 18-05	257	Rp 1 1/4" NPT 1 1/4"	98	2.7
ST 18-06	279		98	2.8
ST 18-08	322		98	3.1
ST 18-11	387		98	3.6
ST 18-14	452		98	4.1
ST 18-19	560		98	4.9
ST 18-25	763		98	6.9
ST 18-30	885		98	8.1

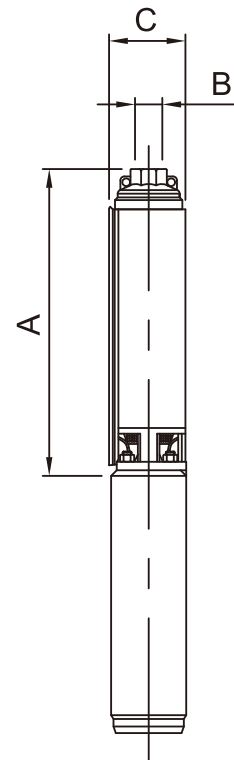



### Performance Curves

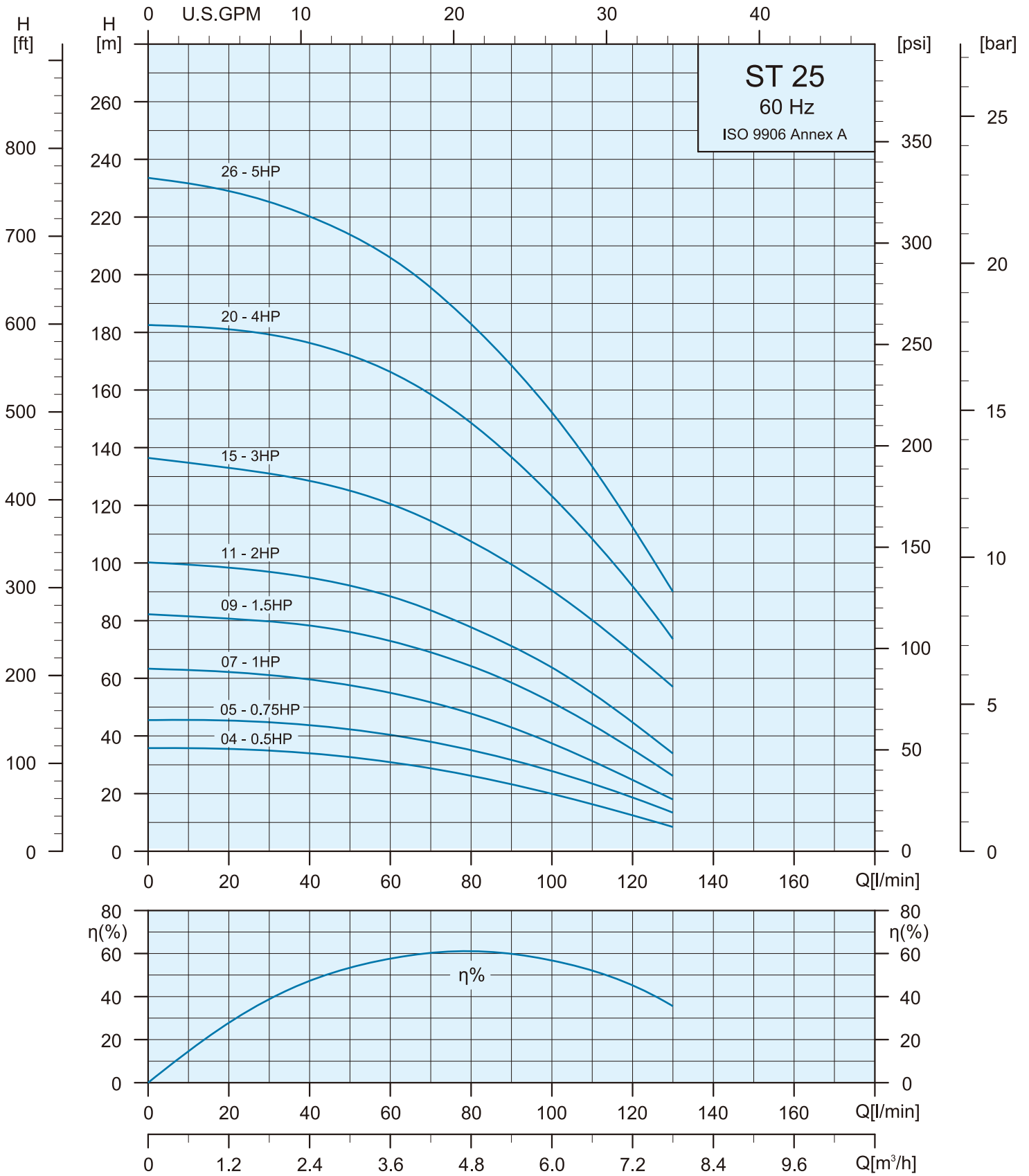

### Specifications

Pump Type	Motor		Q=DELIVERY								
	P <sub>2</sub>		l/min	0	50	60	70	80	90	100	120
	kW	HP	m <sup>3</sup> /h	0	3.0	3.6	4.2	4.8	5.4	6.0	7.2
ST 25-04	0.37	0.5	H (m)	36	33	31	29	27	23	20	12
ST 25-05	0.55	0.75		46	42	40	38	35	32	28	19
ST 25-07	0.75	1.0		63	58	55	52	48	43	37	25
ST 25-09	1.1	1.5		82	76	73	69	64	58	52	35
ST 25-11	1.5	2.0		100	92	88	84	78	71	64	45
ST 25-15	2.2	3.0		136	125	121	115	107	100	90	69
ST 25-20	3	4.0		183	172	166	158	148	137	122	92
ST 25-26	3.7	5.0		234	214	206	196	183	169	152	112

### Dimensions and Weights

Pump Type	Dimensions (mm)			Net Weight (kg)
	A	B	C	PUMP
ST 25-04	247	Rp 1 1/2" NPT 1 1/2"	98	2.4
ST 25-05	272		98	2.6
ST 25-07	320		98	3.1
ST 25-09	370		98	3.5
ST 25-11	419		98	3.9
ST 25-15	518		98	4.7
ST 25-20	679		98	5.8
ST 25-26	864		98	8.1

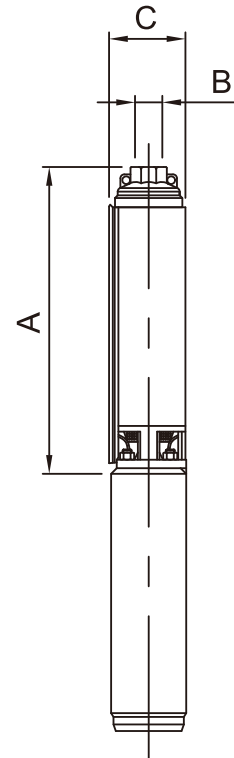

### Performance Curves

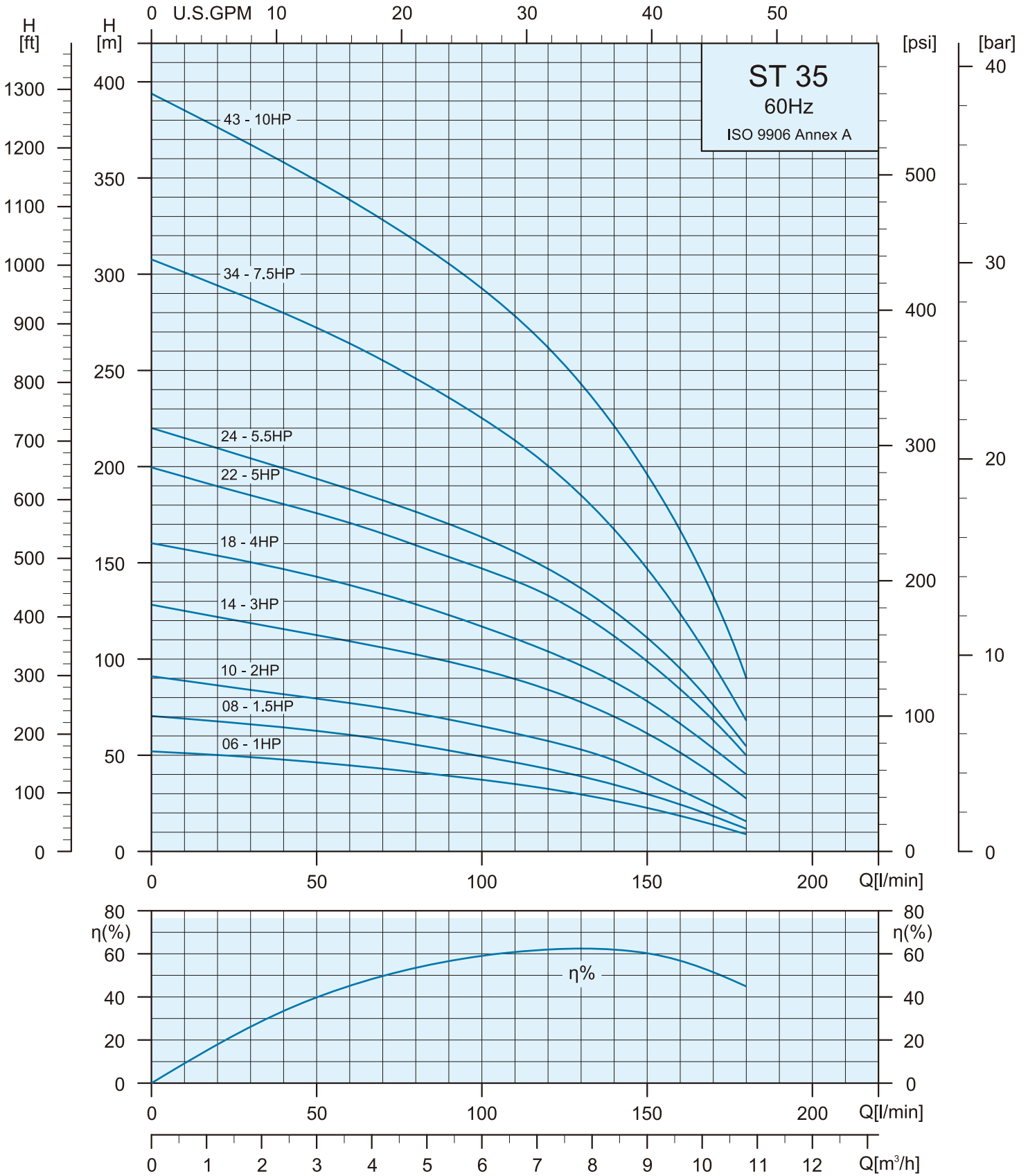

### Specifications

Pump Type	Motor		Q=DELIVERY										
	P <sub>2</sub>		l/min	0	60	70	80	90	100	120	140	160	180
	kW	HP	m <sup>3</sup> /h	0	3.6	4.2	4.8	5.4	6.0	7.2	8.4	9.6	10.8
ST 35-06	0.75	1.0	H (m)	52	44	43	42	40	38	33	27	18	9
ST 35-08	1.1	1.5		70	60	58	55	52	50	43	35	24	12
ST 35-10	1.5	2.0		91	77	75	72	69	65	58	48	32	17
ST 35-14	2.2	3.0		128	109	106	102	99	94	83	70	51	29
ST 35-18	3.0	4.0		160	139	133	129	123	117	104	89	67	40
ST 35-22	3.7	5.0		200	170	165	159	152	147	132	111	84	50
ST 35-24	4.0	5.5		220	189	182	177	170	162	148	125	95	55
ST 35-34	5.5	7.5		308	263	255	246	236	225	200	167	122	69
ST 35-43	7.5	10.0		394	339	328	317	305	292	261	220	167	90

### Dimensions and Weights

Pump Type	Dimensions (mm)			Net Weight (kg)
	A	B	C	PUMP
ST 35-06	359	Rp 2" NPT 2"	98	3.4
ST 35-08	421		98	4.0
ST 35-10	483		98	4.6
ST 35-14	607		98	5.7
ST 35-18	731		98	6.9
ST 35-22	893		98	8.1
ST 35-24	993		98	9.7
ST 35-34	1325		98	12.6
ST 35-43	1676		98	15.2

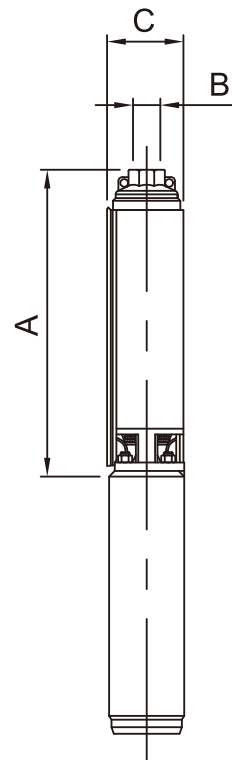

### Performance Curves

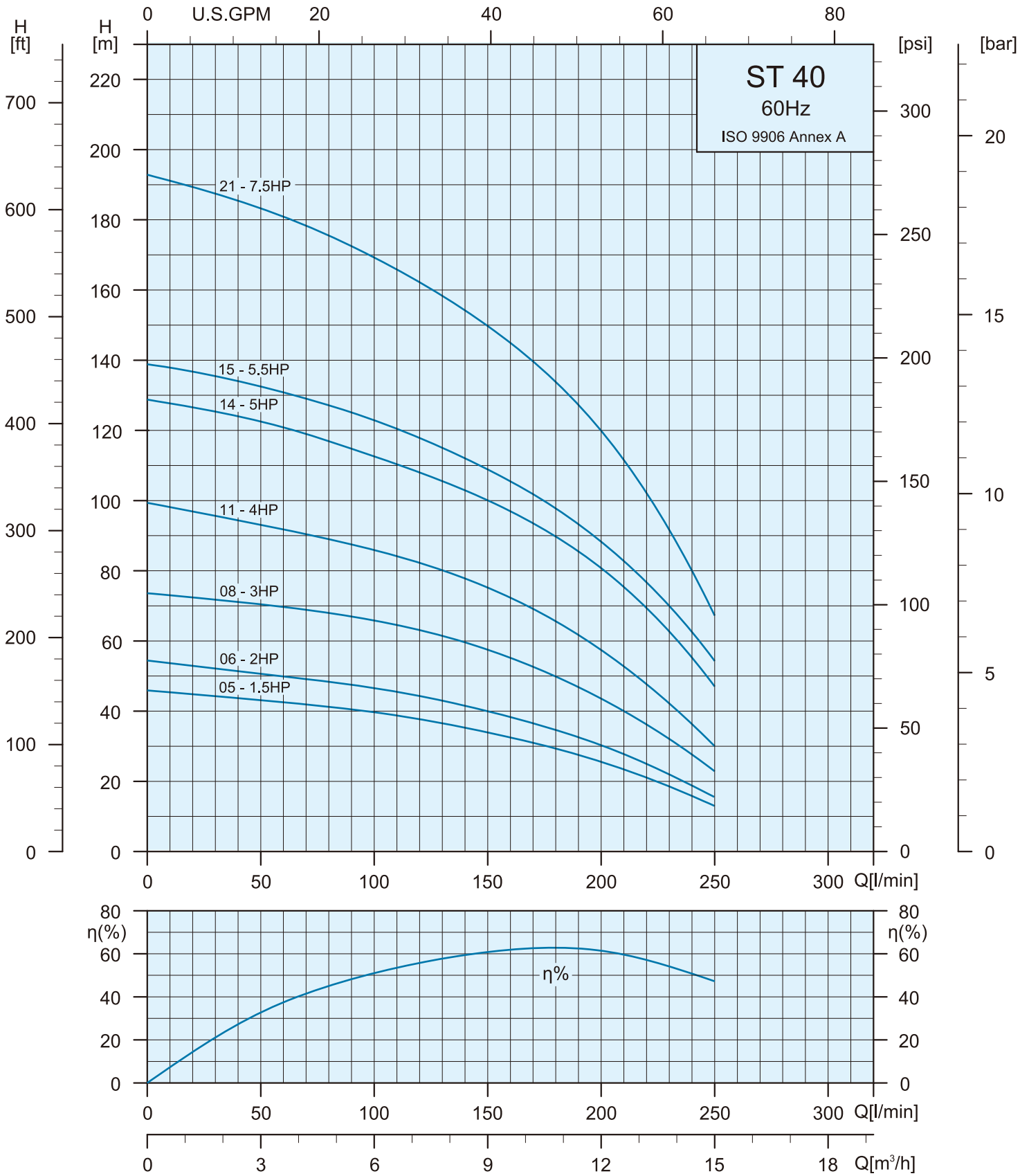

### Specifications

Pump Type	Motor		Q=DELIVERY											
	P <sub>2</sub>		l/min	0	70	80	90	100	120	140	160	180	200	250
	kW	HP	m <sup>3</sup> /h	0	4.2	4.8	5.4	6.0	7.2	8.4	9.6	10.8	12.0	15.0
ST 40-05	1.1	1.5	H (m)	46	42	41	40	39	37	35	33	29	25	14
ST 40-06	1.5	2.0		55	49	48	47	47	45	42	38	35	30	17
ST 40-08	2.2	3.0		74	69	68	67	66	63	60	56	50	43	24
ST 40-11	3.0	4.0		100	91	88	87	86	83	78	73	66	58	30
ST 40-14	3.7	5.0		129	118	116	115	113	108	103	97	90	81	48
ST 40-15	4.0	5.5		139	128	126	125	123	118	113	105	97	88	55
ST 40-21	5.5	7.5		194	178	175	173	169	162	154	145	134	120	68

### Dimensions and Weights

Pump Type	Dimensions (mm)			Net Weight (kg)
	A	B	C	PUMP
ST 40-05	325	Rp 2" NPT 2"	98	3.1
ST 40-06	356		98	3.4
ST 40-08	418		98	4.0
ST 40-11	511		98	4.9
ST 40-14	604		98	5.7
ST 40-15	638		98	6.0
ST 40-21	859		98	7.8

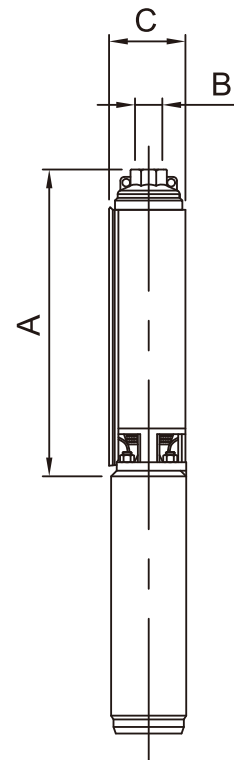

### Performance Curves

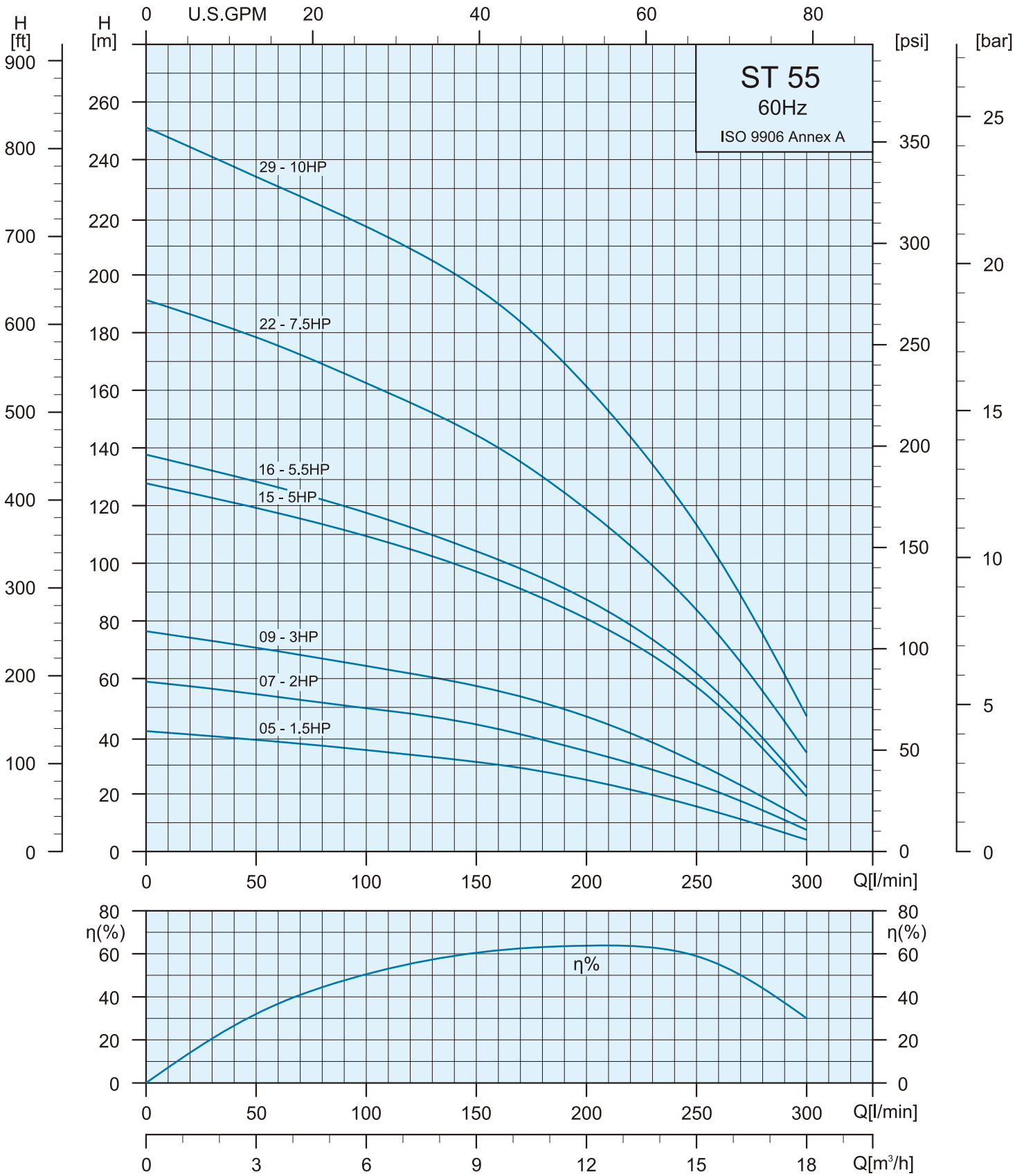

### Specifications

Pump Type	Motor		Q=DELIVERY														
	P <sub>2</sub>		l/min m <sup>3</sup> /h	0	80	90	100	120	140	160	180	200	220	240	260	280	300
	kW	HP		0	4.8	5.4	6.0	7.2	8.4	9.6	10.8	12.0	13.2	14.4	15.6	16.8	18.0
ST 55-05	1.1	1.5	H (m)	42	38	37	36	34	32	30	28	25	22	18	14	9	5
ST 55-07	1.5	2.0		59	52	51	50	48	46	43	40	36	31	26	21	15	8
ST 55-09	2	3.0		76	67	66	64	62	59	56	52	47	42	35	28	19	11
ST 55-15	3.7	5.0		128	113	112	109	105	100	94	88	80	72	63	51	37	20
ST 55-16	4.0	5.5		137	122	120	117	112	107	101	95	88	79	68	55	40	23
ST 55-22	5.5	7.5		191	169	166	162	156	149	140	131	118	106	91	75	55	35
ST 55-29	7.5	10		251	225	221	218	209	200	190	177	161	144	125	101	75	48

### Dimensions and Weights

Pump Type	Dimensions (mm)			Net Weight (kg)
	A	B	C	
ST 55-05	433	Rp 2" NPT 2"	98	4.3
ST 55-07	537		98	5.3
ST 55-09	641		98	6.2
ST 55-15	953		98	9.0
ST 55-16	1005		98	9.5
ST 55-22	1410		98	13.3
ST 55-29	1775		98	16.6

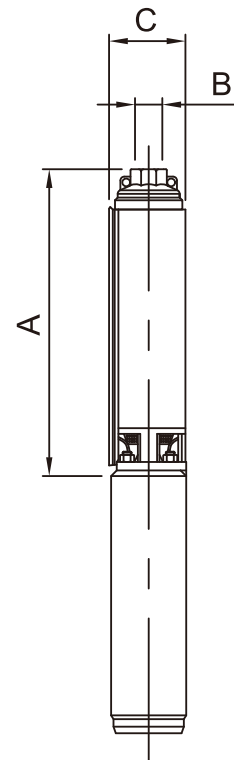



### Performance Curves

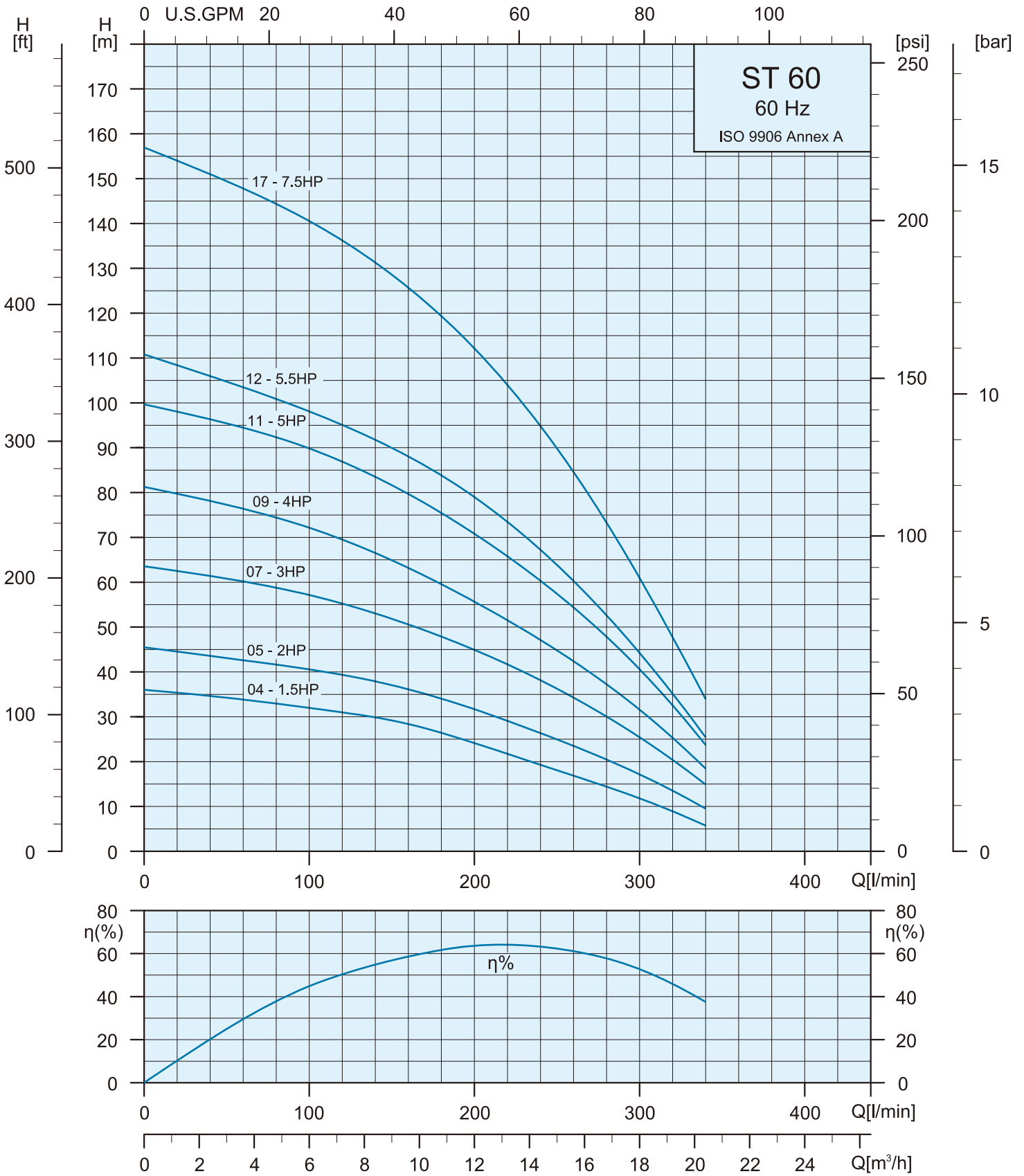

### Specifications

Pump Type	Motor		Q=DELIVERY													
	P <sub>2</sub>		l/min	0	100	120	140	160	180	200	220	240	260	280	300	340
	kW	HP	m <sup>3</sup> /h	0	6.0	7.2	8.4	9.6	10.8	12	13.2	14.4	15.6	16.8	18	20.4
ST 60-04	1.1	1.5	H (m)	36	32	31	30	28	26	24	22	19	17	14	12	6
ST 60-05	1.5	2.0		46	41	39	37	36	34	32	29	26	23	20	17	9
ST 60-07	2.2	3.0		64	57	55	53	51	48	45	42	38	34	30	25	15
ST 60-09	3.0	4.0		82	72	69	67	64	60	56	52	47	42	37	32	18
ST 60-11	3.7	5.0		100	90	87	83	80	75	71	67	60	54	48	41	24
ST 60-12	4.0	5.5		110	98	95	92	88	84	78	73	67	60	55	44	26
ST 60-17	5.5	7.5		157	140	136	131	126	119	112	104	95	85	73	61	35

### Dimensions and Weights

Pump Type	Dimensions (mm)			Net Weight (kg)
	A	B	C	PUMP
ST 60-04	378	Rp 2" NPT 2"	98	3.9
ST 60-05	430		98	4.4
ST 60-07	534		98	5.3
ST 60-09	638		98	6.3
ST 60-11	742		98	7.2
ST 60-12	797		98	7.7
ST 60-17	1092		98	10.1

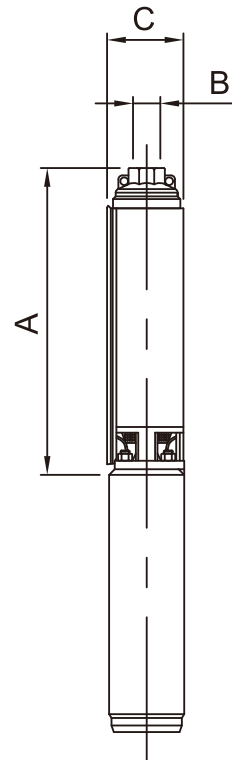

### Performance Curves

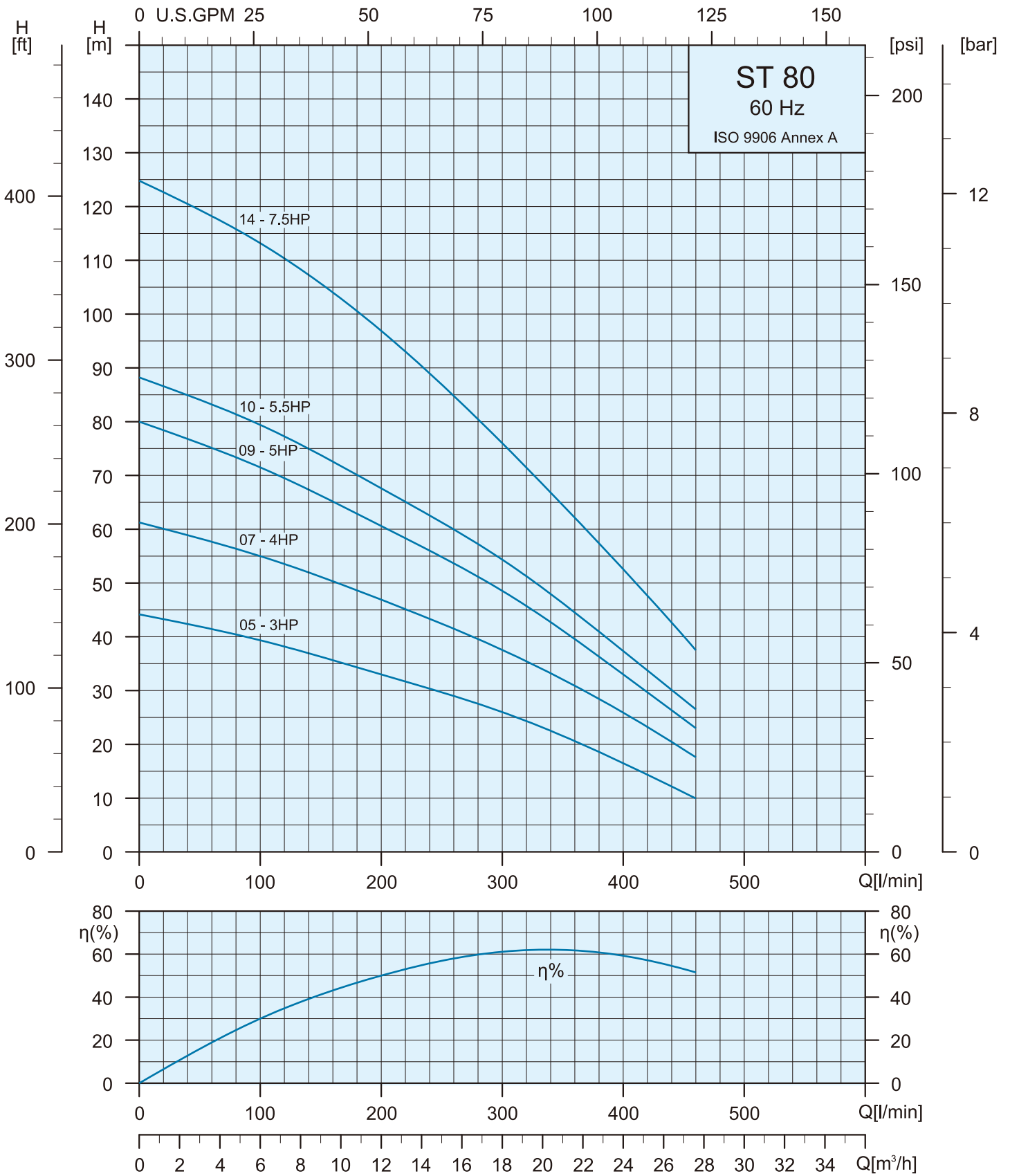

### Specifications

Pump Type	Motor		Q=DELIVERY													
	P <sub>2</sub>		l/min	0	160	180	200	220	240	260	280	300	340	380	420	460
	kW	HP	m <sup>3</sup> /h	0	9.6	10.8	12.0	13.2	14.4	15.6	16.8	18.0	20.4	22.8	25.2	27.6
ST 80-05	2.2	3.0	H (m)	44	36	34	33	32	30	29	28	26	23	19	14	10
ST 80-07	3.0	4.0		61	50	49	47	45	43	41	40	38	33	28	23	18
ST 80-09	3.7	5.0		80	65	63	61	58	56	54	51	49	43	36	30	23
ST 80-10	4.0	5.5		88	73	70	68	65	63	60	57	54	48	41	34	27
ST 80-14	5.5	7.5		126	104	101	97	93	89	85	80	76	67	62	48	38

### Dimensions and Weights

Pump Type	Dimensions (mm)			Net Weight (kg)
	A	B	C	
ST 80-05	472	Rp 2" NPT 2"	98	4.4
ST 80-07	608		98	5.6
ST 80-09	743		98	6.9
ST 80-10	814		98	7.5
ST 80-14	1081		98	9.9

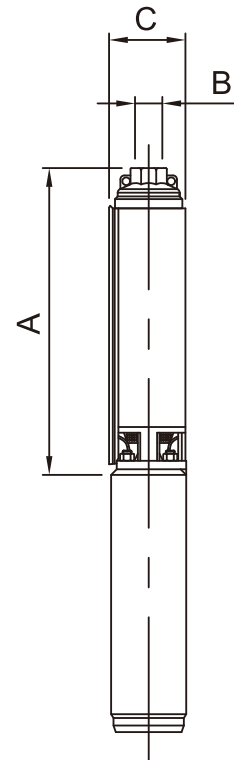

### Performance Curves

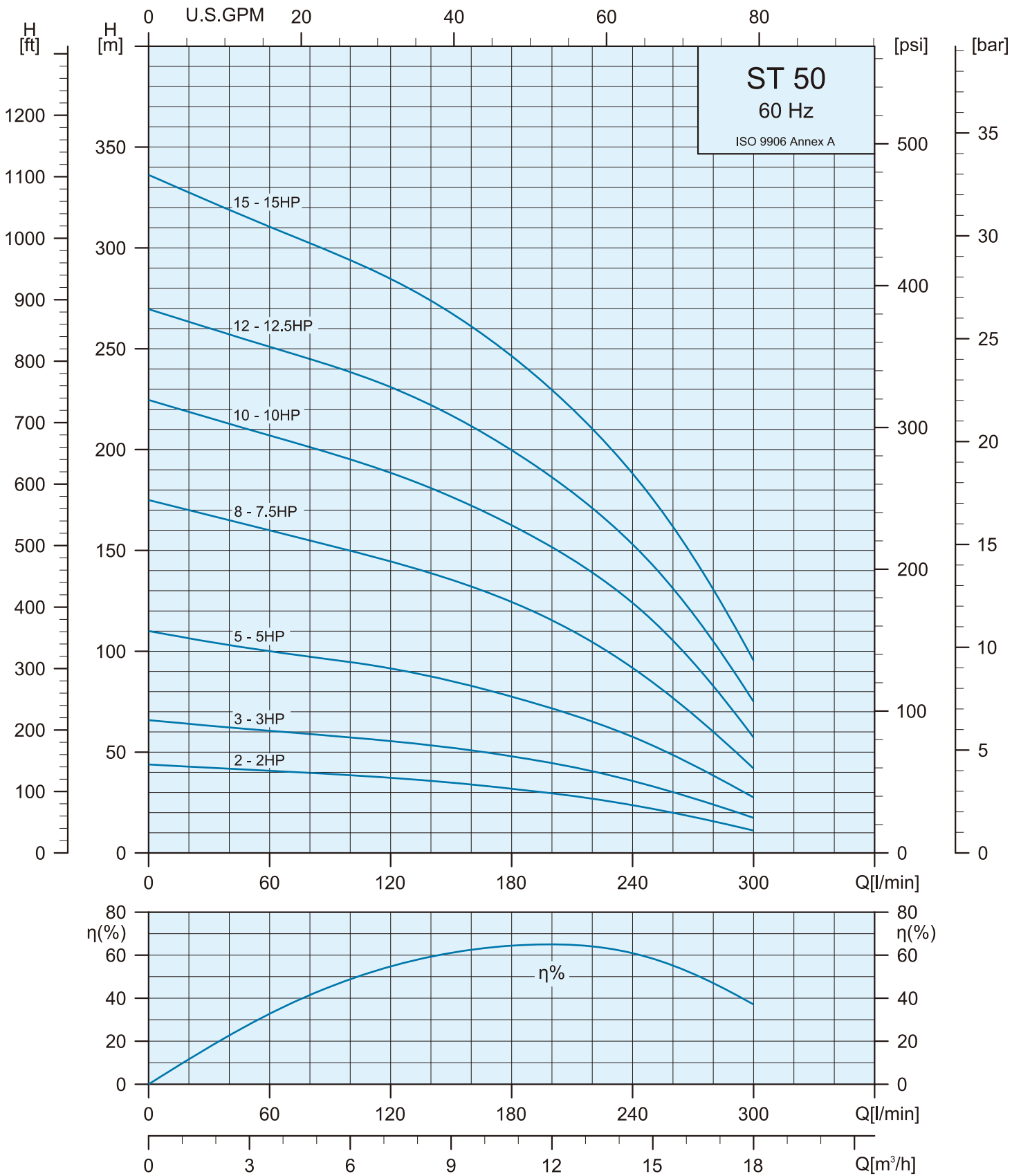

### Specifications

Pump Type	Motor		Q=DELIVERY											
	kW	HP	l/min	0	120	140	160	180	200	220	240	260	280	300
			m <sup>3</sup> /h	0	7.2	8.4	9.6	10.8	12.0	13.2	14.4	15.6	16.8	18.0
ST 50-02	1.5	2.0	H (m)	44	37	35	34	32	29	27	23	20	15	11
ST 50-03	2.2	3.0		66	55	53	51	48	44	40	35	30	24	17
ST 50-05	3.7	5.0		110	91	87	83	77	71	65	57	48	38	27
ST 50-08	5.5	7.5		175	144	138	132	124	115	104	91	77	60	42
ST 50-10	7.5	10.0		224	188	181	172	162	151	139	124	105	83	57
ST 50-12	9.3	12.5		269	231	222	211	200	186	171	153	131	105	75
ST 50-15	11.0	15.0		336	284	274	261	246	229	210	188	161	130	95

### Dimensions and Weights

Pump Type	Motor Type	Dimensions (mm)					Net Weight (kg)
		A	B	C	C*	C**	
ST 50-02	4"	425	RP 3" NPT 3"	138	—	—	8.2
ST 50-03		463		138	—	—	8.9
ST 50-05		539		138	—	—	10.3
ST 50-08		653		138	—	—	12.5
ST 50-10		729		138	—	—	13.8
ST 50-08	6"	667		—	141	144	13.2
ST 50-10		743		—	141	144	14.6
ST 50-12		819		—	141	144	15.9
ST 50-15		933	—	141	144	17.8	

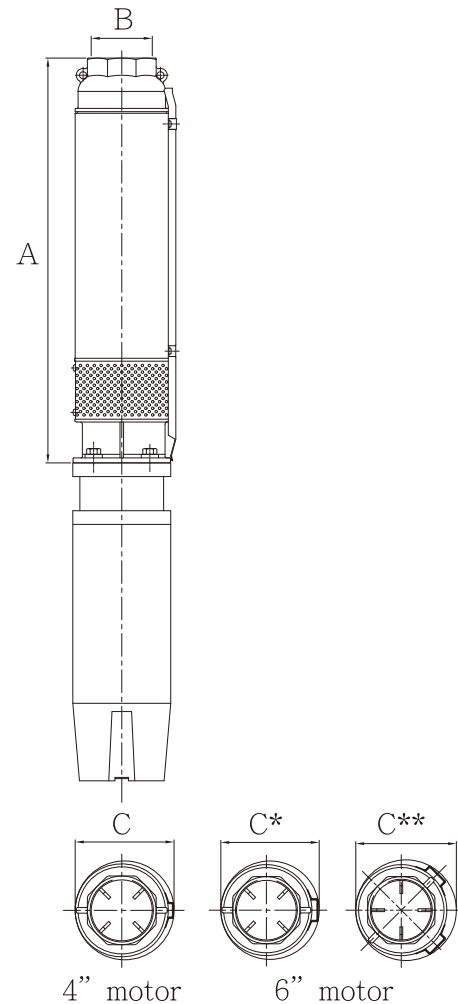

### Performance Curves

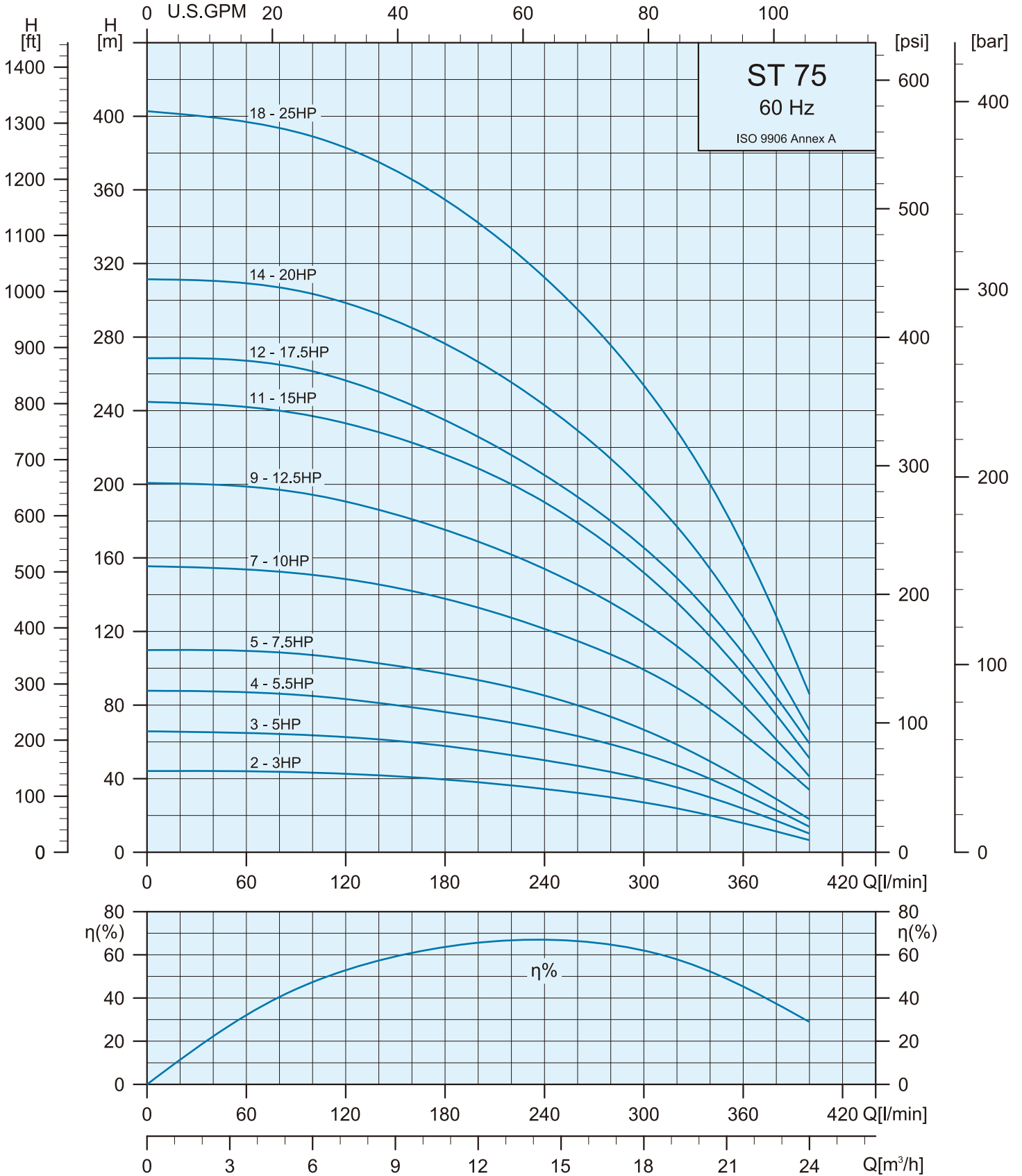

### Specifications

Pump Type	Motor		l/min m <sup>3</sup> /h	Q=DELIVERY												
	kW	HP		0	160	180	200	220	240	260	280	300	320	340	360	380
				0	9.6	10.8	12	13.2	14.4	15.6	16.8	18	19.2	20.4	21.6	22.8
ST 75-02	2.2	3.0	H (m)	44	41	39	38	36	34	32	30	27	24	20	16	11
ST 75-03	3.7	5.0		65	59	57	55	53	50	47	43	40	35	30	23	17
ST 75-04	4.0	5.5		87	78	76	73	70	67	63	58	53	47	40	31	23
ST 75-05	5.5	7.5		110	100	97	93	89	85	80	73	66	58	49	39	29
ST 75-07	7.5	10.0		155	142	137	133	127	121	115	107	99	89	77	64	49
ST 75-09	9.3	12.5		200	181	175	169	162	154	145	135	124	112	97	80	61
ST 75-11	11.0	15.0		244	222	216	208	200	190	179	166	152	135	117	97	74
ST 75-12	13.0	17.5		268	243	235	226	216	205	193	180	165	149	130	108	84
ST 75-14	15.0	20.0		311	285	276	266	255	243	229	214	196	177	154	127	98
ST 75-18	18.5	25.0		402	365	354	342	328	312	295	275	253	229	200	166	128

### Dimensions and Weights

Pump Type	Motor Type	Dimensions (mm)					Net Weight (kg)
		A	B	C	C*	C**	
ST 75-02	4"	425	Rp 3" NPT 3"	138	—	—	8.2
ST 75-03		463		138	—	—	8.9
ST 75-04		501		138	—	—	9.6
ST 75-05		539		138	—	—	10.3
ST 75-07		615		138	—	—	11.7
ST 75-05	6"	553		—	141	144	11.1
ST 75-07		629		—	141	144	12.5
ST 75-09		705		—	141	144	13.9
ST 75-11		781		—	141	144	15.2
ST 75-12		819		—	141	144	15.8
ST 75-14		895	—	141	144	17.2	
ST 75-18		1047	—	141	144	19.9	

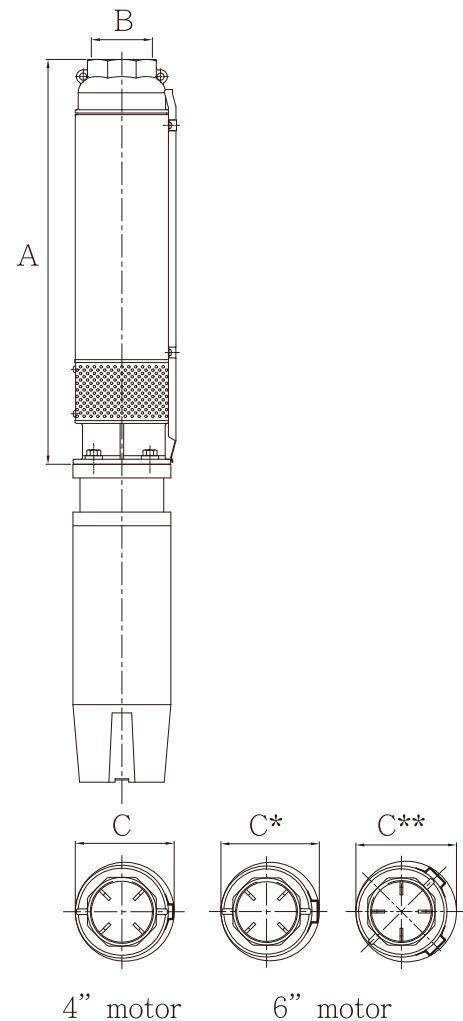



### Performance Curves

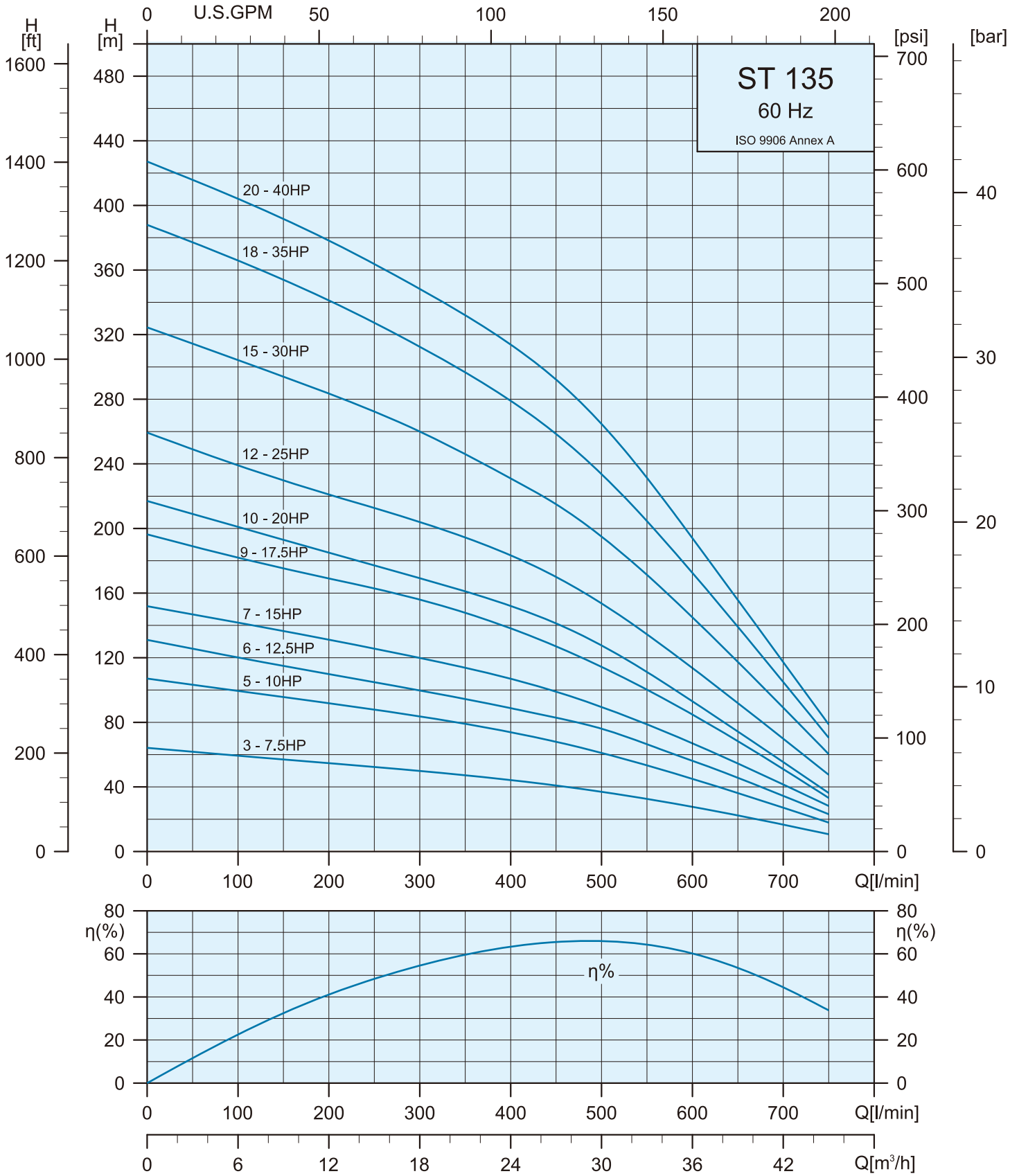

### Specifications

Pump Type	Motor		H (m)	Q=DELIVERY													
	kW	HP		l/min	0.0	200	250	300	350	400	450	500	550	600	650	700	750
				m <sup>3</sup> /h	0.0	12.0	15.0	18.0	21.0	24.0	27.0	30.0	33.0	36.0	39.0	42.0	45.0
ST 135-03	5.5	7.5	H (m)	64	54	52	50	47	44	41	37	32	27	22	16	10	
ST 135-05	7.5	10.0		107	91	88	83	79	74	68	61	53	45	36	27	18	
ST 135-06	9.3	12.5		131	109	105	99	94	88	83	76	66	56	45	34	23	
ST 135-07	11.0	15.0		152	131	125	120	113	107	99	89	78	67	54	41	28	
ST 135-09	13.0	17.5		196	169	162	156	147	138	127	114	100	85	68	51	33	
ST 135-10	15.0	20.0		217	185	177	169	161	152	141	127	111	93	74	55	36	
ST 135-12	18.5	25.0		259	221	212	204	194	183	170	153	134	113	92	70	47	
ST 135-15	22.0	30.0		324	283	272	260	246	231	215	195	171	145	117	89	60	
ST 135-18	26.0	35.0		388	341	327	312	296	279	258	233	204	172	139	105	70	
ST 135-20	30.0	40.0		427	378	363	348	332	314	292	264	231	194	155	117	78	

### Dimensions and Weights

Pump Type	Motor Type	Dimensions (mm)					Net Weight (kg)
		A	B	C	C*	C**	
ST 135-03	4"	520	Rp 3" NPT 3"	138	—	—	9.9
ST 135-05		634		138	—	—	11.8
ST 135-03	6"	534		—	141	144	10.7
ST 135-05		648		—	141	144	12.5
ST 135-06		705		—	141	144	13.5
ST 135-07		762		—	141	144	14.4
ST 135-09		876		—	141	144	16.1
ST 135-10		933		—	141	144	17
ST 135-12		1047		—	141	144	18.9
ST 135-15		1218		—	141	144	21.6
ST 135-18		1389		—	141	144	24.3
ST 135-20		1555		—	141	144	27

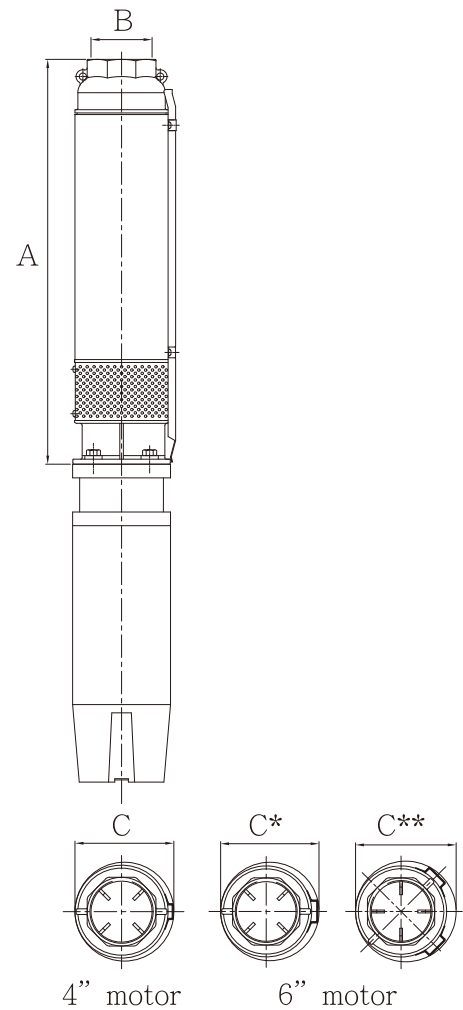

### Performance Curves

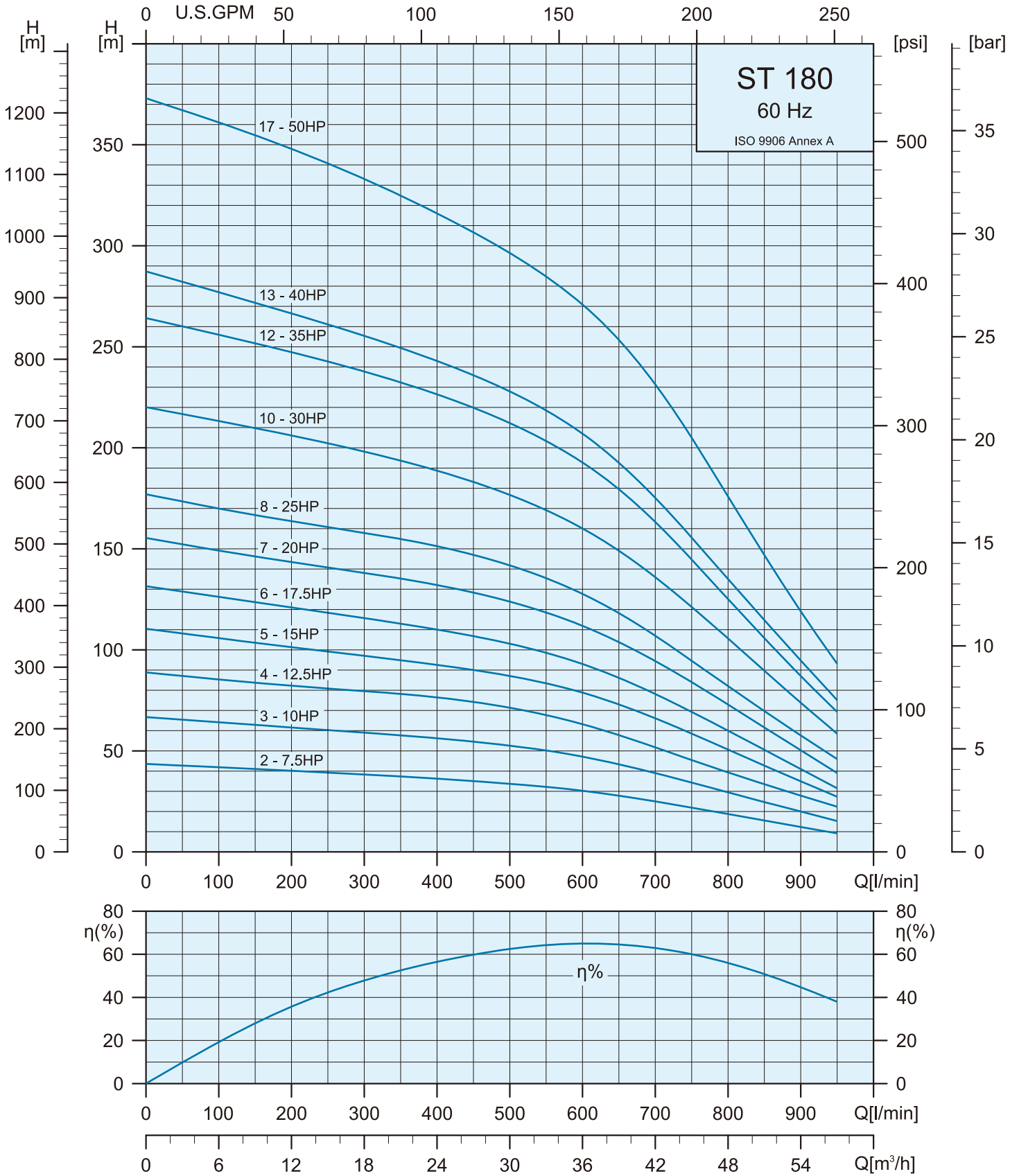

### Specifications

Pump Type	Motor		l/min m <sup>3</sup> /h	Q=DELIVERY												
	kW	HP		0	350	400	450	500	550	600	650	700	750	800	850	900
				0	21	24	27	30	33	36	39	42	45	48	51	54
ST 180-02	5.5	7.5	H (m)	43	37	36	35	33	32	30	28	25	22	18	15	12
ST 180-03	7.5	10.0		66	57	56	54	52	50	47	43	39	34	29	24	20
ST 180-04	9.3	12.5		89	78	76	74	71	67	63	57	51	45	39	33	28
ST 180-05	11.0	15.0		110	95	93	90	87	83	79	73	66	58	50	42	35
ST 180-06	13.0	17.5		131	113	110	106	103	98	93	86	78	69	60	50	41
ST 180-07	15.0	20.0		155	135	132	128	124	118	112	104	94	84	73	61	50
ST 180-08	18.5	25.0		177	155	151	147	142	135	127	118	107	94	82	69	57
ST 180-10	22.0	30.0		220	193	189	183	176	169	160	149	136	121	105	89	74
ST 180-12	26.0	35.0		264	232	226	220	212	203	192	179	163	144	125	105	87
ST 180-13	30.0	40.0		287	249	243	236	228	218	207	192	175	155	135	114	94
ST 180-17	37.0	50.0		373	324	316	306	296	284	271	253	231	205	176	147	119

### Dimensions and Weights

Pump Type	Motor Type	Dimensions (mm)					Net Weight (kg)
		A	B	C	C*	C**	
ST 180-02	4"	469	Rp 3" NPT 3"	138	—	—	8.9
ST 180-03		529		138	—	—	9.9
ST 180-02	6"	483		—	141	144	9.8
ST 180-03		543		—	141	144	10.7
ST 180-04		603		—	141	144	11.6
ST 180-05		663		—	141	144	12.6
ST 180-06		723		—	141	144	13.6
ST 180-07		783		—	141	144	14.5
ST 180-08		843		—	141	144	15.5
ST 180-10		963		—	141	144	17.4
ST 180-12		1083		—	141	144	19.2
ST 180-13		1143		—	141	144	20.3
ST 180-17	1435	—	141	144	24.9		

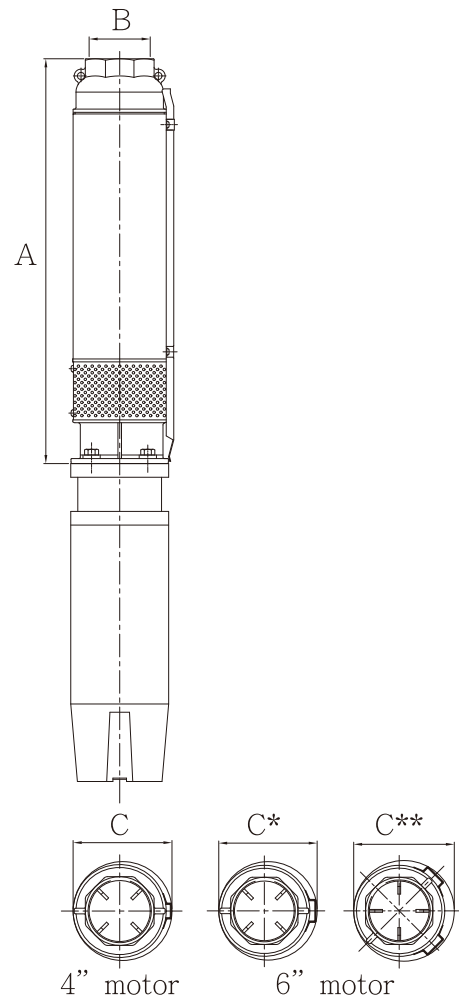

### Performance Curves

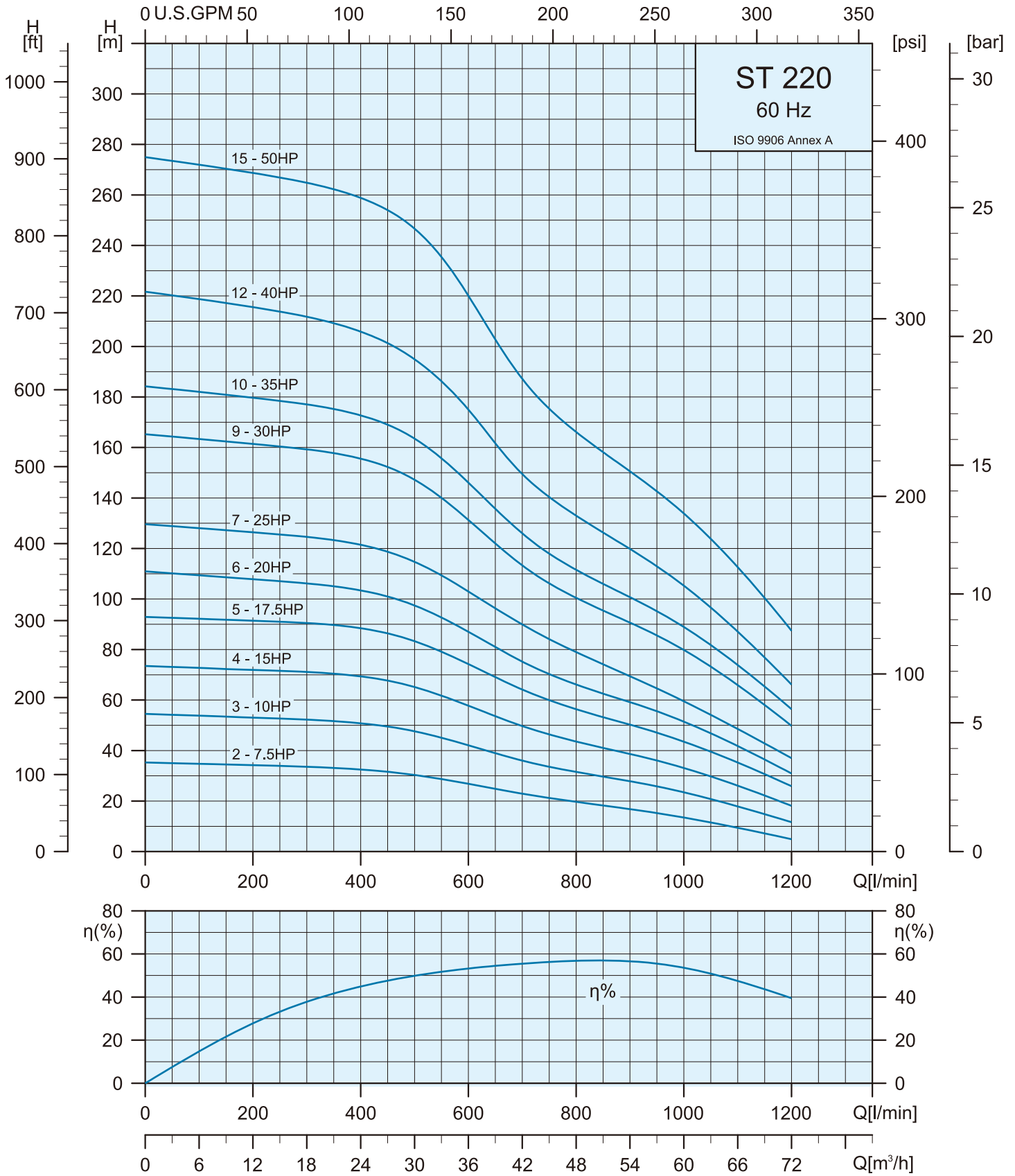

### Specifications

Pump Type	Motor		Q=DELIVERY														
	kW	HP	l/min m <sup>3</sup> /h	0	450	500	550	600	650	700	750	800	850	900	1000	1100	1200
ST 220-02	5.5	7.5	H (m)	0	27	30	33	36	39	42	45	48	51	54	60	66	72
ST 220-03	7.5	10.0		35	31	30	28	27	25	23	21	19	18	16	13	9	5
ST 220-04	11.0	15.0		54	49	47	45	42	39	36	33	31	29	28	23	17	11
ST 220-05	13.0	17.5		73	67	65	61	57	53	49	46	43	41	38	33	26	18
ST 220-06	15.0	20.0		93	86	83	79	74	69	64	60	56	53	50	43	35	26
ST 220-07	18.5	25.0		111	101	97	92	87	81	75	70	66	62	59	51	41	31
ST 220-09	22.0	30.0		129	118	114	109	103	96	90	84	79	74	69	59	48	37
ST 220-10	26.0	35.0		165	152	147	140	131	122	113	106	100	95	90	80	66	50
ST 220-12	30.0	40.0		184	169	163	155	146	135	126	118	111	106	100	89	74	56
ST 220-15	37.0	50.0		221	201	195	186	175	161	149	140	133	126	120	105	87	66
				275	254	246	235	220	202	187	175	166	158	150	134	112	87

### Dimensions and Weights

Pump Type	Motor Type	Dimensions (mm)					Net Weight (kg)
		A	B	C	C*	C**	
ST 220-02	4"	469	Rp 3" NPT 3"	138	—	—	8.9
ST 220-03		529		138	—	—	9.9
ST 220-02	6"	483		—	141	144	9.8
ST 220-03		543		—	141	144	10.7
ST 220-04		603		—	141	144	11.7
ST 220-05		663		—	141	144	12.6
ST 220-06		723		—	141	144	13.5
ST 220-07		783		—	141	144	14.5
ST 220-09		903		—	141	144	16.5
ST 220-10		963		—	141	144	17.5
ST 220-12		1083		—	141	144	19.5
ST 220-15		1263		—	141	144	22.6

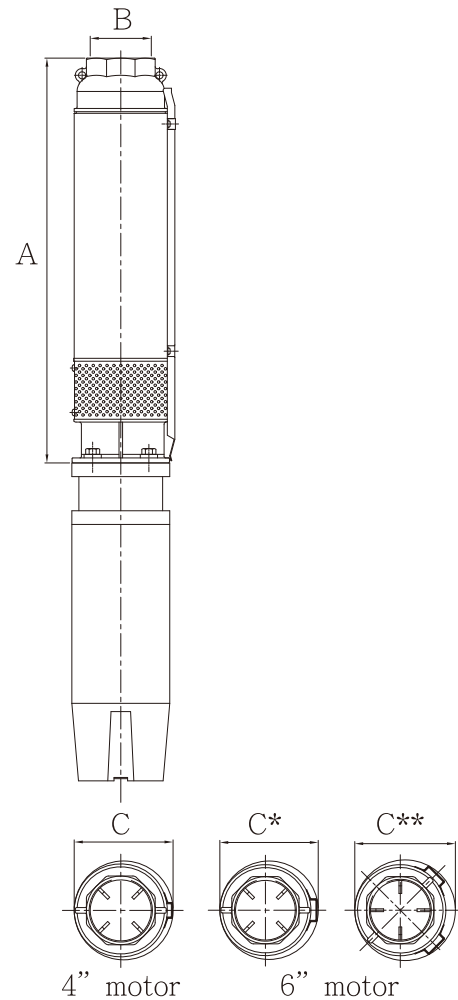



 **STAIRS**

No.6-7-1,Shanzijiao, Lucao Township, Chiayi County 61158, Taiwan  
Tel: +886 5 3750488 Fax: +886 5 3755658  
[www.stairs.com.tw](http://www.stairs.com.tw) E-mail:[stairs@stairs.com.tw](mailto:stairs@stairs.com.tw)

1120111

